

GBC MC12 Wire Closer

User's Manual



Provided By

MyBinding.com®
When Image Matters.



**Model MC 12
TWIN LOOP
MANUAL CLOSER**

Instruction Manual & Parts List

OPERATING INSTRUCTIONS TWIN LOOP MANUAL CLOSER

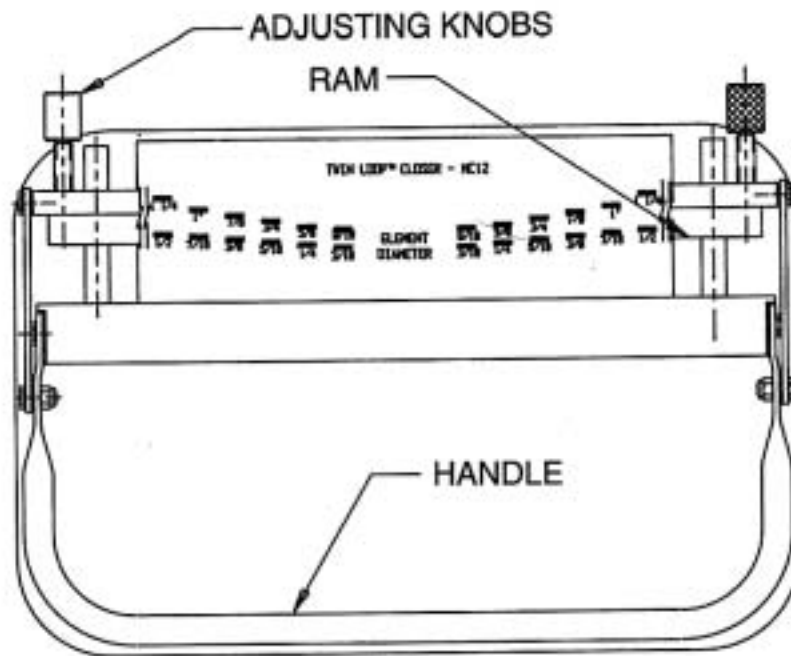

INSTRUCTIONS:

- Measure book thickness and determine element size from chart.
- Measure binding edge and determine number of loops per inch. Measure edge in inches, then multiply by number of loops per inch and subtract 1.

Example: 11" binding edge at 3 loops per inch = 33 - 1
(32 loops for an 11" binding edge)

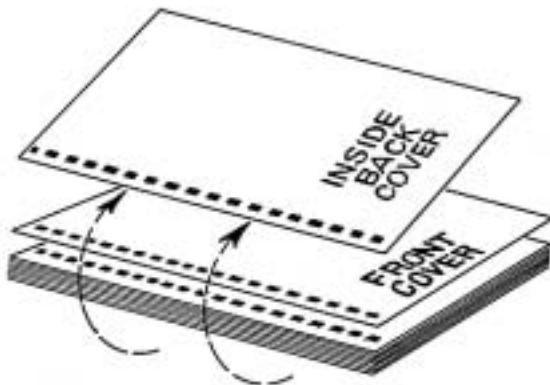

- Stack book with front cover up. Rotate back cover to top. This ensures that wire loop closure will be inside of book.



START ELEMENT



INSERT ELEMENT

- Turn book over (cover down). Insert wire elements into book.

Insert product into the Manual Closer between the ram and the stationary block. Pull the handle down until the element is closed properly. (Refer to notes below for proper element closing). If the element is not closed properly, adjust the ram accordingly with the adjusting knobs.

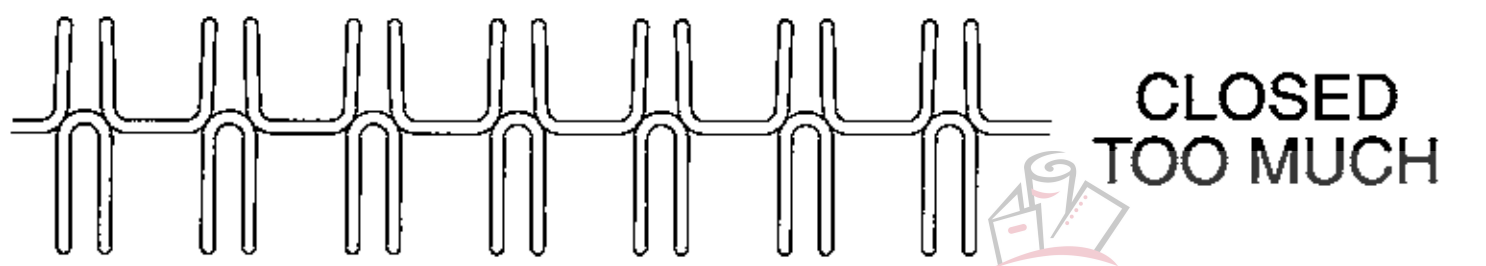
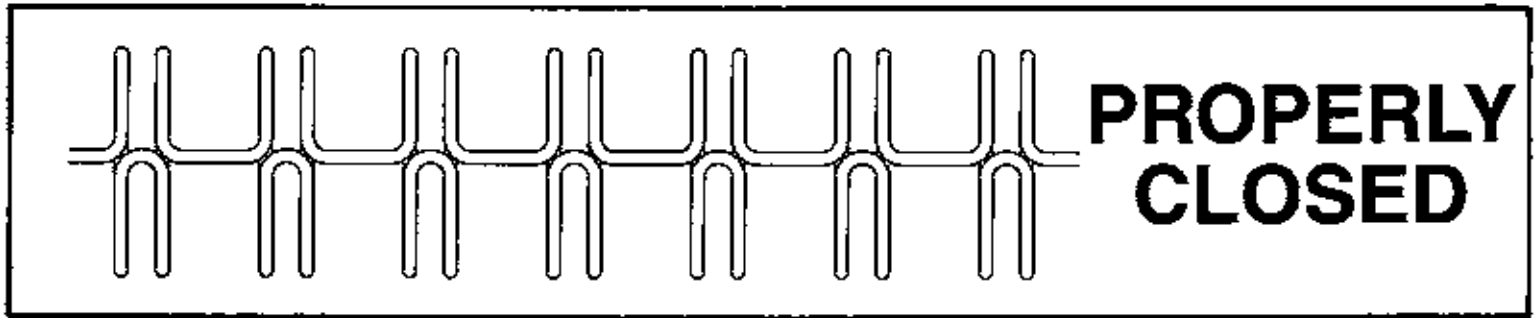
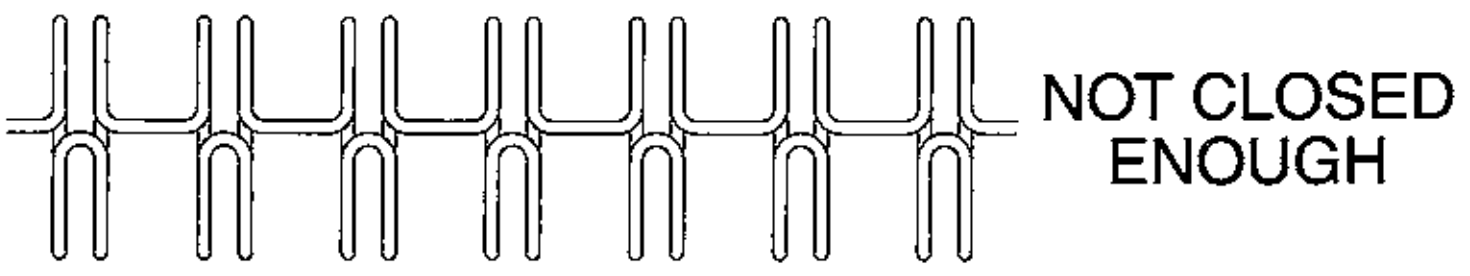
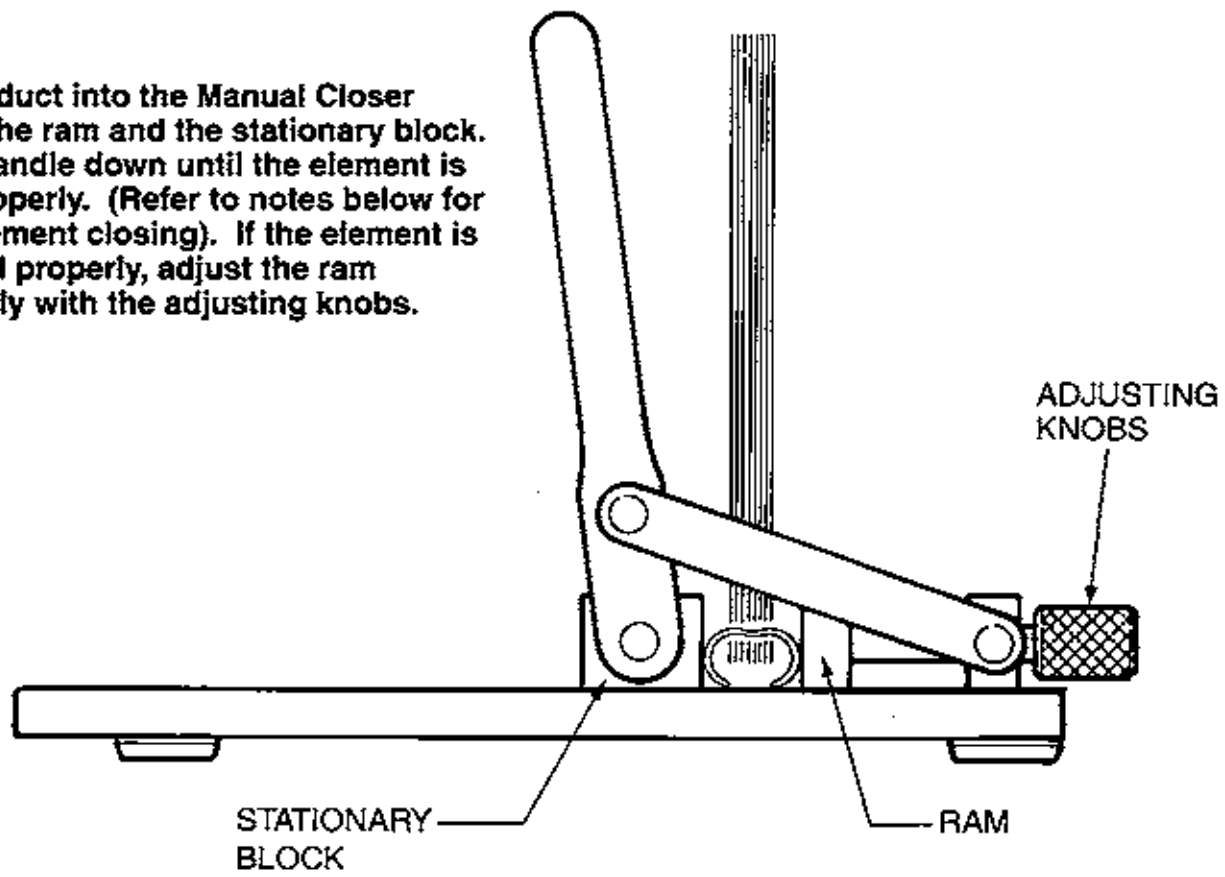

FIGURE 1

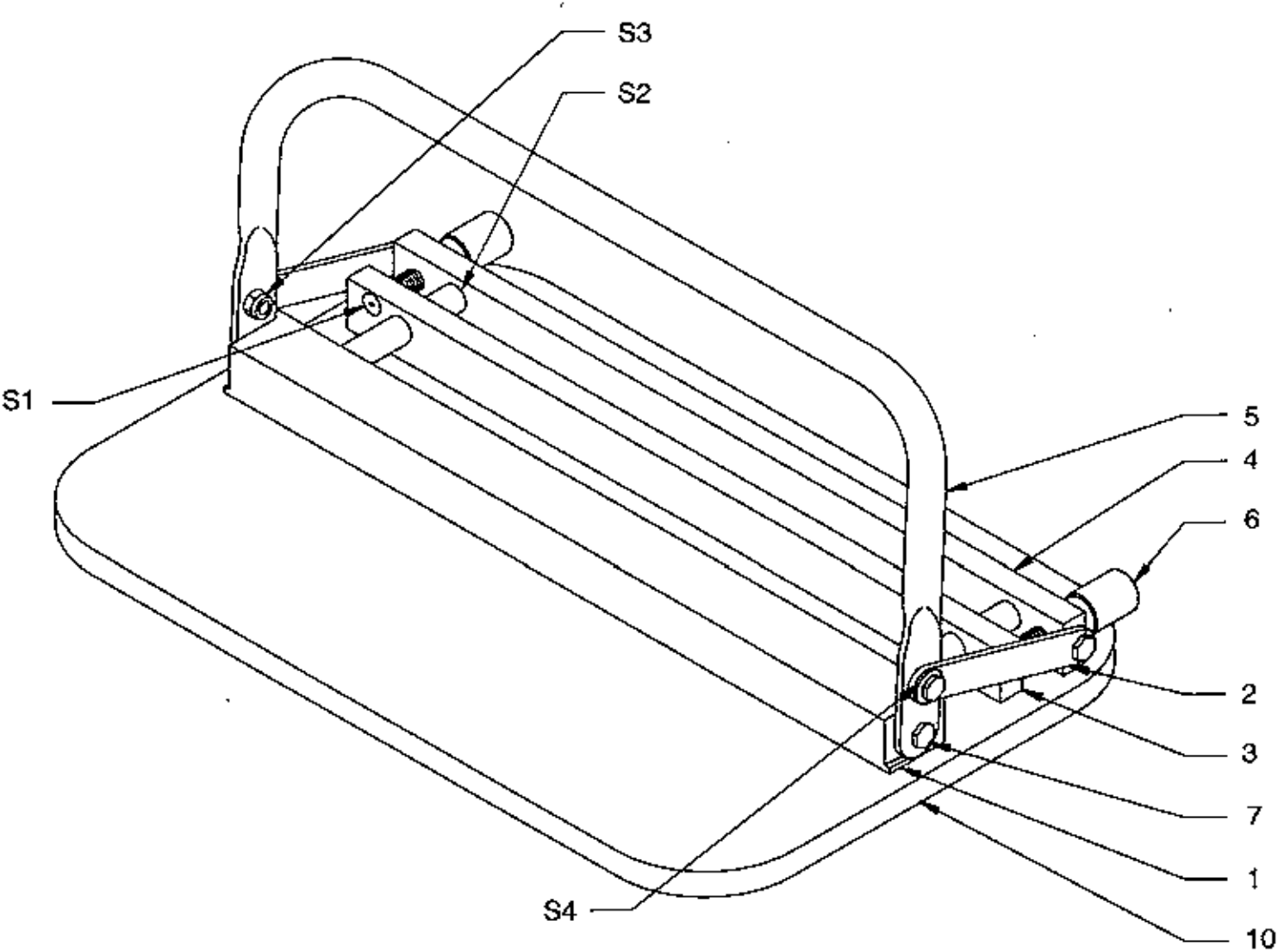
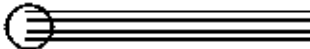
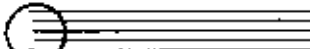
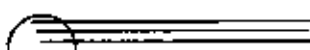

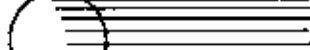
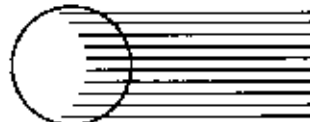



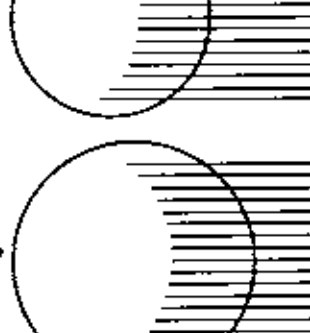

FIGURE 1 PARTS LIST

ITEM NO.	SICKINGER PART NO.	DESCRIPTION	QUANTITY REQUIRED
1	1450001	BLOCK, STATIONARY	1
2	1450002	LINK	2
3	1450003	RAM	1
4	1450004	ACTUATOR BAR	1
5	1450005	HANDLE	1
6	1450006	KNOB - ADJUSTING	2
7	1450007	SHOULDER SCREW - HEX	6
8	4800128	LABEL - MANUAL CLOSER	1 (NOT SHOWN)
9	4800129	LABEL - LOGO	1 (NOT SHOWN)
10	4800780	BASE	1
11	7501800	FEET - SELF ADHESIVE	4 (NOT SHOWN)

STANDARD PARTS LIST

S1	7502300	SHOULDER SCREW - 1/4 DIA X 3/8	2
S2	7502679	DOWEL PIN - 1/2 DIA X 4"	2
S3	7503047	LOCK NUT - ESNA 1/4-20	2
S4	7504123	WASHER - .622 OD X .317 ID X .06 THK	6
S5	7508645	FHCS - 1/4-20 X 3/4	4 (NOT SHOWN)

ELEMENT SIZE		BOOK THICKNESS
3 LOOPS PER INCH		
1/4"		3/16" OR LESS
5/16"		1/4" OR LESS
3/8"		5/16" OR LESS
7/16"		3/8" OR LESS
1/2"		7/16" OR LESS
9/16"		1/2" OR LESS
2 LOOPS PER INCH		
5/8"		9/16" OR LESS
3/4"		5/8" OR LESS
7/8"		3/4" OR LESS
1"		7/8" OR LESS
1-1/4"		1-1/8" OR LESS



One GBC Plaza
Northbrook, Illinois 60062

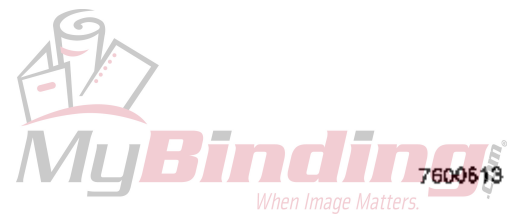

We Have it All...



MyBinding.com

When Image Matters.

Guaranteed Lowest Prices on an Endless Selection of Binding Systems, Laminators, Paper Shredders, Supplies and Accessories.

We have you covered with Expert Advice and Support. Our popular blog keeps you up to date on the latest tips and techniques to make your most important binding and laminating tasks a success.

Call Us Today

1-800-944-4573

Our Trusted Partners

GBC / Ibico

Fellowes

Powis Fastback

Unibind

Akiles

Renz

Tamerica

Rhin-O-Tuff

DFG

Pro-Bind

Martin Yale

MBM

Formax

Intimus

Dahle

HSM

Standard

Xyron

Challenge

Lasko-Wizer

GBC Shredmaster

Avery

Wilson Jones

Cardinal

Samsill

Universal

- BINDING MACHINES
- BINDING SUPPLIES
- LAMINATORS
- I.D. ACCESSORIES
- BOARDS & EASELS
- PAPER SHREDDERS
- XYRON LAMINATORS
- COIL BINDING MACHINES
- UNIBIND BINDING MACHINES
- FASTBACK BINDING EQUIPMENT
- PAPER FOLDING MACHINES
- LAMINATING POUCHES
- ROTARY TRIMMERS
- CLEAR COVERS
- TWIN LOOP WIRE
- REGENCY COVERS
- PLASTIC BINDING COVERS
- VELOBIND BINDING MACHINES
- PAPER HANDLING EQUIPMENT
- THERMAL BINDING MACHINES
- PROCLICK BINDING SYSTEMS
- COMB BINDING MACHINES
- COMB BINDING SUPPLIES
- WIRE BINDING MACHINES
- POUCH LAMINATORS
- LAMINATING ROLLS
- 3-RING BINDERS
- ROLL LAMINATORS
- VELOBIND SPINES
- PAPER CUTTERS
- PAPER JOGGERS
- LETTER OPENERS
- THERMAL COVERS
- UNIBIND SUPPLIES
- PROCLICK SPINES
- ZIPBIND SPINES
- LINEN COVERS
- SPIRAL COIL
- INDEX TABS

