

CHALLENGE TITAN 200 PAPER CUTTER

Instruction Manual



Provided By

MyBinding.com®
When Image Matters.

Serial Numbers 032425 & Up

OPERATION MANUAL



The Challenge Machinery Company
6125 NortonCenter Drive
Norton Shores, MI 49441-6081 USA

ChallengeMachinery.com

TITAN 200 ***PAPER CUTTING*** ***MACHINE***

Sold and Serviced by



F.200-CO
August 2003

When Image Matters.

1.0 Introduction

THIS MANUAL is designed to help you get the most from your Challenge equipment. Keep this manual in a safe, convenient place for quick reference by operators and service personnel.

! CAUTION SAFETY ALERT! This symbol means **CAUTION: Personal safety instructions!** Pay special attention to the instructions in bold type. Personal injury may result if the precautions are not read and followed.

READ THIS MANUAL BEFORE OPERATING! Follow precautions and instructions given and you should have years of trouble-free operation. If after reading the manual questions still remain, contact your Authorized Challenge Dealer.

Take a few minutes right now to **RECORD YOUR MACHINE SERIAL NUMBER** in the space provided on the front cover of this manual. Also be sure to fill out the warranty card accompanying your machine and return it **DIRECTLY TO CHALLENGE**.

If you bought a used machine, it is important to have the following information on record at Challenge. Copy this page, fill in the information and send it care of The Challenge Service Department • 6125 Norton Center Drive • Norton Shores, MI 49417-1594.

CHALLENGE MODEL	SERIAL NUMBER	
ATTN	COMPANY	
ADDRESS		
CITY	STATE/PROVINCE	ZIP
PHONE	DATE INSTALLED	
DEALER NAME & CITY		

*** WARRANTY INFORMATION ***

It is very important that you read and understand the conditions outlined in the *Warranty Information Sheet* attached to the outside of the shipping container of your machine.

The *Warranty Information Sheet* must be filled out completely and returned to THE CHALLENGE MACHINERY COMPANY in order for the warranty to be issued for this machine.

Challenge® is a registered trademark of The Challenge Machinery Company • 6125 Norton Center Drive • Norton Shores, MI 49441-6081
 Copyright© 2003 by The Challenge Machinery Company. All rights reserved. Printed in the U.S.A

TABLE OF CONTENTS

1.0 Introduction	2
2.0 Safety	5
2.1 Precautions	5
2.2 Power Lockout Procedure	5
2.3 Warning Label Definitions	6
3.0 Packing List	7
4.0 Specifications	8
5.0 Installation & Setup	9
5.1 Inspecting Shipment	9
5.2 Uncrating	9
5.3 Cleaning	10
5.4 Fitting Through Narrow Door	10
5.4.1 Removing the Table	10
5.4.2 Removing the Foot Treadle	13
5.4.3 Removing the Front Guard (If Equipped)	13
5.4.4 Reattaching the Table	13
5.5 Installing Optional Extension Tables (Front Guard Machines Only)	14
5.6 Hydraulic System Check	14
5.7 False Clamp Plate (Optional)	15
5.8 Power Hook-Up	16
5.9 Line Light	16
5.9.1 Adjustment	17
5.9.2 Bulb Replacement	17
6.0 Operation	18
6.1 Power – Main Switch	18
6.2 Start Up	18
6.3 Making a Cut (Machines With Electric Eyes)	19
6.4 Making a Cut (Machines With Front Guard)	19
6.5 Jogging Aid	19
6.6 Knife Change Alarm and Lubrication Alarm	20
6.7 Manual Clamping (Using the Foot Treadle)	20
6.8 Display Panel	21
6.9 Definition of Keys	21
6.9.1 Variable Speed Pinpoint Backgauge Control	21
6.9.2 IN/MM Key	21
6.9.3 Send Key	21
6.9.4 Push-Out Key/Hold-To-Run Backgauge Key	22
6.9.5 Clear Key	22
6.9.6 Enter Key	22
6.9.7 Priority Add (X/Y) Key	22
6.9.8 Soft-Keys	22
6.9.9 Arrow Keys	22
6.9.10 Contrast Control (Serial Numbers 083330 and Below)	22
6.9.11 Contrast Control (Serial Numbers 083331 and Above)	22
6.10 Manual Backgauge Control	23
6.10.1 Backgauge Glide Control	23
6.10.2 Backlash Indicator	23
6.11 Send Mode	23
6.11.1 Entering Math	23
6.11.2 Entering Fractions	24
6.12 Maintenance Mode	24
6.12.1 Knife Adjust	24
6.12.2 Parameters	24

1.0 Introduction

6.12.3 Diagnostic	26
6.12.4 Language	27
6.13 Job Mode.....	27
6.13.1 Lock/Unlocking a Job.....	27
6.13.2 Copying a Job	27
6.13.3 Erasing a Job	27
6.13.4 Creating a New Job	28
6.13.5 Editing an Existing Job.....	29
6.13.6 Running a Programmed Job.....	30
6.13.7 Exiting a Job	30
6.14 An Example Job	30
6.15 Operating Tips.....	32
6.16 Note to Dealer	32
6.16.1 Entering the Dealer Name and Phone Number.....	32
7.0 Knife Installation/Changing.....	33
7.1 Knife Removal	33
7.2 Knife Installation	35
7.3 Knife Care Tips.....	36
7.3.1 Knife Blade Life.....	36
7.3.2 Cutting Stick.....	37
7.3.3 Bevel Angle.....	37
7.3.4 Helpful Suggestions	37
7.3.5 Knife Care	37
8.0 Oil and Grease.....	40
9.0 Titan 200 Floor Plan	43
10.0 Safety Systems Test.....	44

2.0 Safety

2.1 Precautions

- This machine is designed for one-person operation. Never operate the machine with more than one person.
- Safe use of this machine is the responsibility of the operator. Use good judgment and common sense when working with and around this machine.
- Read and understand all instructions thoroughly before using the machine. If questions remain, contact the dealer from which you purchased this machine. Failure to understand the operating instructions may result in personal injury.
- Only trained and authorized people should operate this machine.
- **DO NOT ALTER SAFETY GUARDS OR DEVICES.** They are for your protection. Severe personal injury may result.
- **Disconnect power** before cleaning or performing maintenance. See Section 2.2 Power Lockout Procedure.
- Observe all caution labels on this machine.
- Be sure the cutter is properly grounded.
- Be sure there is sufficient power to operate the cutter properly.
- Observe all caution plates mounted on this cutter.
- Keep foreign objects off table and away from cutter blade.
- **BE EXTREMELY CAREFUL** when handling and changing the cutter knife. Severe lacerations or dismemberment could result from careless handling procedures.
- Keep the floor around the cutter free of trim, debris, oil and grease.
- When replacing hydraulic parts, loosen the connections slowly to release pressure. Never loosen connections with the machine running.
- If the cutter sounds or operates unusually, turn it off and consult the troubleshooting section of this manual. If the problem cannot be corrected, have it checked by a qualified service person.
- **CRUSH HAZARD**, keep hand and fingers from under the clamp when clamping paper. Use Jogging Aid to load paper, and use the backgauge to push paper out before unloading. **DO NOT REACH UNDER THE KNIFE AND CLAMP AREA!**

2.2 Power Lockout Procedure

For maximum safety while making adjustments or repairs to your machine, be sure to disconnect power to the machine. Disconnect the power plug from its socket

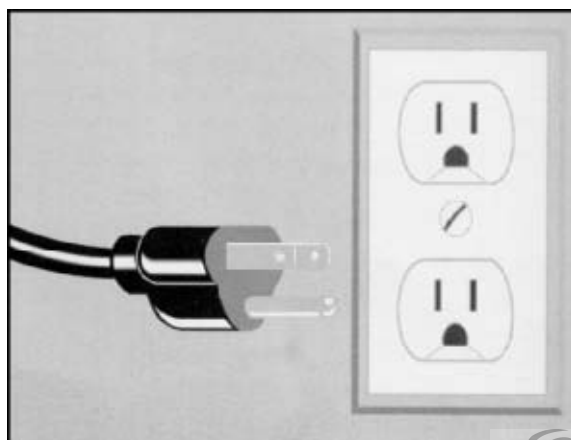

Figure 1 - Main Power Disconnect

2.3 Warning Label Definitions

The following warning labels are found at various locations on your machine. Read and understand the meaning of each symbol. If a label is lost from the machine, it should be replaced.



HAZARDOUS AREA

Disconnect power before cleaning, servicing, or making adjustments not requiring power. Do not alter safety guards or devices; they are for your protection. Replace all guards. Do not operate with any guards removed.



SHOCK HAZARD

Disconnect power before removing cover. Replace cover before operation.



SHOCK HAZARD

Disconnect power before removing cover. Replace cover before operation.



SINGLE OPERATOR

Do not operate with more than one person.

3.0 Packing List



Part No.	Description	Qty.
A-10034	Knife	2
4166	Cutting Stick (in addition to one installed in machine)	3
F.200-CO	Operator Manual	1
A-12608-2	Jogging Aid	1
20-2150-2	Tool Kit	1
H-6918-608	Knife Bolts, 3/8 – 16 x 1"	4
8815	Knife Washers, Special	4
5064	Cutting Stick Puller	1
43108	Knife Lifter Assembly	1
W-130	3/16" Allen Wrench	1
W-137	5/32" Allen Wrench	1
W-164	5/16" Hex 'T' Wrench	1
W-170	9/16 x 1/2" Wrench	1
SU-10-113	Grease Brush	1

Optional Items

Part No.	Description	Qty.
AA-10061	False Clamp Plate	
5-7-M361	Backgauge Book Guides	
4166	Cutting Stick	
A-10034-1	High Speed Steel Knife	

4.0 Specifications

Description	Inch Units	Metric Units
Cutting Width	20"	51 cm
Minimum Cut*	1/2"	13 mm
Clamp Opening	3 1/4"	8 cm
Table Space		
Front:	15 1/4"	39 cm
Back:	20"	51 cm
Dimensions		
Table Height	36"	91 cm
Overall Height	53"	135 cm
Overall Length***	49"	124 cm
Overall Width	36"	91 cm
Approx. Net Weight	800 lbs	361 kg
Approx. Shipping Weight	920 lbs	418 kg
Electrical		
208/230 Volts, 12 Amps, 1 Phase, 60 Hz, AC. Service size 15 Amps Recommended Recepticle: 208-230 Volt, NEMA 6-15R, NEMA 6-20R UL/cUL Listed		
Sound Emission		
A-weighted sound pressure level measured in an enclosed room at operator level (6 feet/183 cm): Machine cutting a full lift of paper: 77 dB		

*With false clamp plate attached, minimum cut is 1-7/8" (48 mm).

**For complete floor plan layout, see page 43.

***With table, front guard or elec eyes, and foot treadle removed, can be fit through a 28" (71 cm) door opening.

Challenge reserves the right to make changes to any product or specification without notice and without incurring responsibility to existing units.

5.0 Installation & Setup

5.1 Inspecting Shipment

This machine has been carefully packed to prevent damage during shipment. However, claims for damage or loss are the responsibility of the recipient. Inspect all shipments as soon as they are received. If there is any noticeable damage, note it on the freight bill. Visual and/or hidden damage must be reported to the claims department of the carrier within 15 days. Contact your dealer if you need any assistance. Check the contents of the box against the packing list on page 7. Make sure there are no missing items.

5.2 Uncrating

The Titan 200 weighs approximately 755 lbs (342kg). DO NOT risk personal injury or damage by attempting to move machinery with makeshift equipment or inadequate manpower. This machine is shipped on a wooden skid and enclosed in a protective, corrugated top. The skid is designed to allow the machine to be rolled off without any special lifting equipment. The machine is held in place by two, 2x4 braces lag bolted to the skid. All accessories are shipped inside of the machine.

Remove the carton by removing the nails or staples holding it to the skid and lift it straight up over the cutter. If you don't have the ceiling clearance to do this, carefully slit the carton down the side and then unwrap it from around the cutter.

Remove all lag screws from the skid. Remove the lower front cover of the Titan 200 and remove the two lag screws in the base. Remove the accessories.

Using the rear bumper board, pry one side of the machine up, and slide out the top layer of the support riser (Figure 2). Do the same on the other side.



Figure 2

Use the flat board provided as a ramp and position as shown in (Figure 3 on page 10). Hold the ramp in place with the nails provided. Make sure the casters are not locked and very carefully roll the machine down the ramp. The cutter may now be rolled into position.



Figure 3

5.3 Cleaning

After unpacking, wipe down all machine panels and clean the table surface.

5.4 Fitting Through Narrow Door

The Titan 200 cutter will not fit through an opening less than 36" (91 cm) without the table being removed. With the table removed, the Titan 200 will fit through a 35" (89 cm) opening. With the table, front guard, and foot treadle removed, it will fit through a 28" (71 cm) opening.

5.4.1 Removing the Table

Make sure the knife and clamp are in the "up" position. If they are not, read the Power Hookup section (page 16) to connect power to the machine. Turn on the power using the red and yellow main power switch, close the front guard, and press the CLEAR button. This will preset the backgauge and send the knife and clamp up.

Turn off the machine and unplug the power cord.

If equipped with electric eyes, remove the electric eye mounting brackets, the small side tables, and the side table mounting bracket from bottom of table.

Remove the cut buttons from the bottom of the table.

Remove the Plexiglas cover and the three sheet metal covers on the rear of the table. Remove the backgauge motor cover, the rear table support leg, the lower back panel, and the lower front cover of the machine.

Unplug the cable to the encoder at the back of the machine (Figure 4 on page 11).

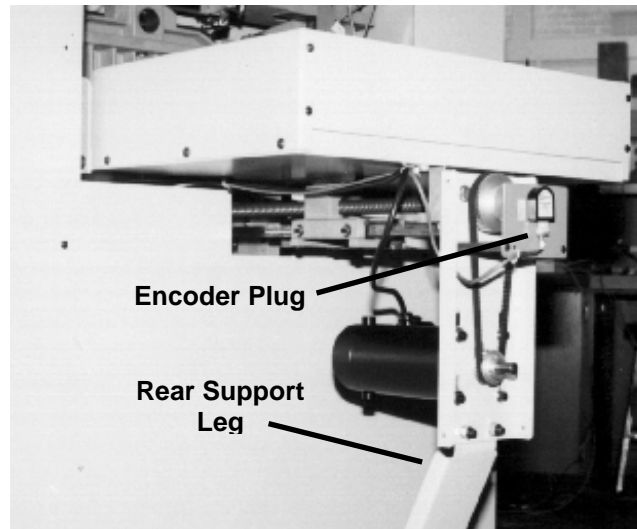

Figure 4

Remove the motor junction box cover and disconnect the wires to the motor (Figure 5). Remove the leadscrew cover and the nylon tyrap that are attached to the bottom of the table. The motor wires and encoder wires should now be free from the table.

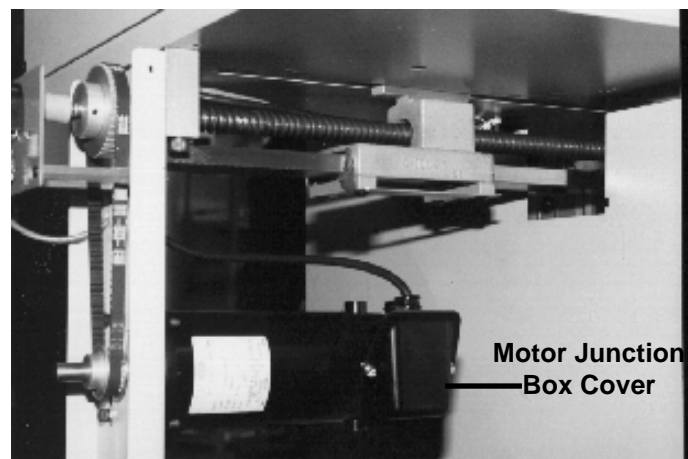

Figure 5

From the rear of the machine, remove the presetter board assembly from the table (Figure 6 on page 12).

Open the front guard (if equipped); open the top cover and remove the left and right side guides and the cut stick stops as shown in (Figure 7 & Figure 8 on page 12).

Next, remove the cut stick from the table using the cut stick removal tool. Locate the two taper pins in the cut stick slot. These must be tapped out from under the base through the table slot and removed. Then remove the four screws that mount the table to the base. NOTE: The table assembly is very heavy and requires two people to remove. Pull the table out from the back of the machine. Locate the four round spacers that were between the table and the base - you will need them later for mounting the table.

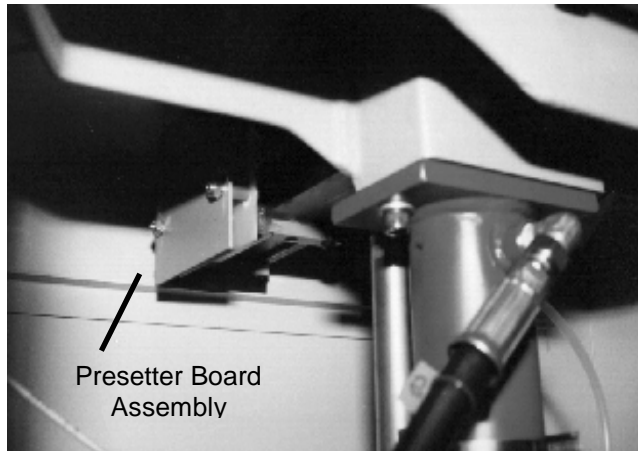

Figure 6

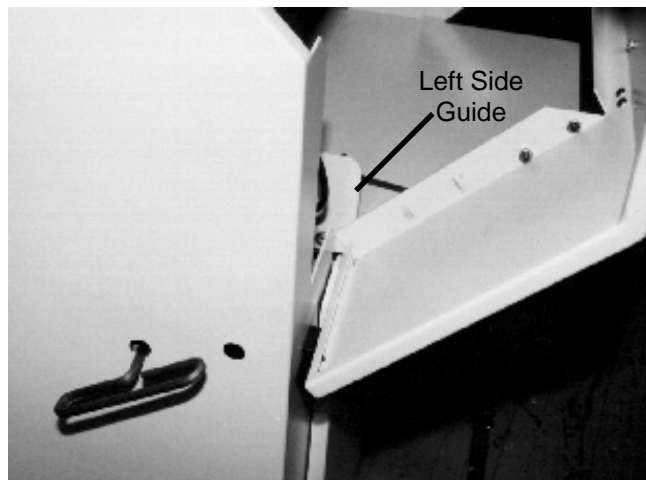

Figure 7

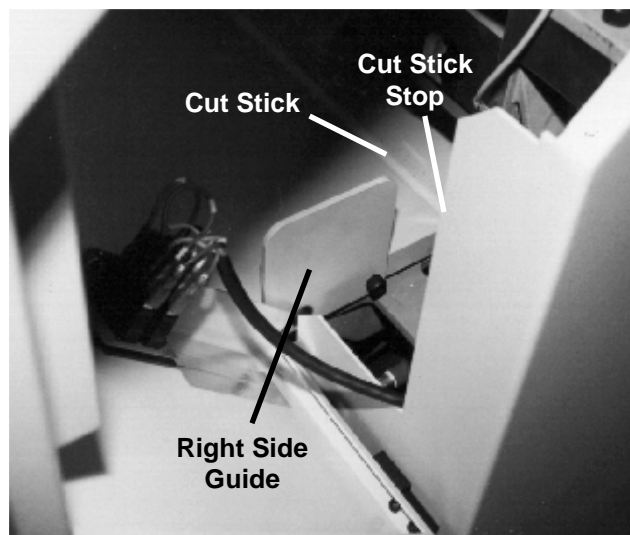

Figure 8

5.4.2 Removing the Foot Treadle

Make sure the power is off and the power cord is disconnected. Remove the lower front cover. Use an open-end wrench to remove the two cables attached to the base, which hold up the foot treadle. Carefully, remove the springs. Now remove the pins at the rear pivot points of the foot treadle. Remove the treadle.

5.4.3 Removing the Front Guard (If Equipped)

Make sure the power is off and disconnect the power cord. Open the front guard. Remove the cylinder bracket screws (Figure 9).

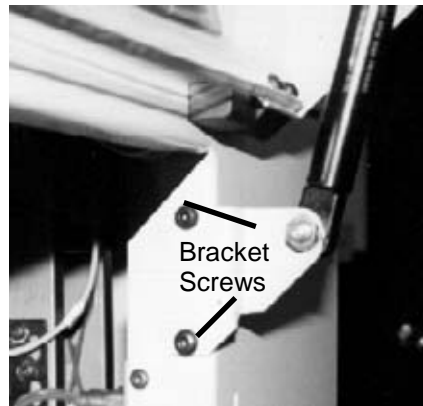

Figure 9

Then open the top hood and remove one set of hinge screws (Figure 10). Slide the front guard out of the other hinge.

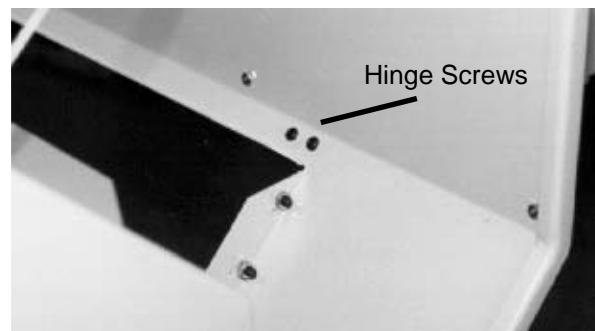

Figure 10

5.4.4 Reattaching the Table

Set the table in position. Lift the table from the front and set the two front spacers in place. Insert the front two socket head screws, but do not tighten. Lift the table from the rear and set the two rear spacers in place. Start the rear two socket head screws. Reinsert the two taper pins, and tap into position so they are below bottom of the slot. Tighten all four screws. Attach the right and left side guides (Figure 7 & Figure 8 on page 12), the presetter board assembly (Figure 6 on page 12), the motor and encoder wires (Figure 4 & Figure 5 on page 11), and all other items that were removed. Once the table is installed, the backgauge squareness and accuracy will have to be reset. See the Titan 200 Technical Service and Parts manual for information on how to do this.

5.5 Installing Optional Extension Tables (Front Guard Machines Only)

Using the wood screws provided, attach a back plate to each extension table. Using (4) 3/8-16 capscrows, attach the table support to the under side of the main table as shown in (Figure 11). Route each cut button wire through the slots in the bracket and relocate the cut buttons to the extension tables (as shown). Place the provided flat washers on the table support above each slot receiving a screw to mount the extension table on the support. Lay the table extension on top of the spacers and insert the screws. Slide the table extension tight to the table. Shim the extension tables as necessary to make the tables flush using the provided shims.

VIEW FROM UNDERNEATH TABLE

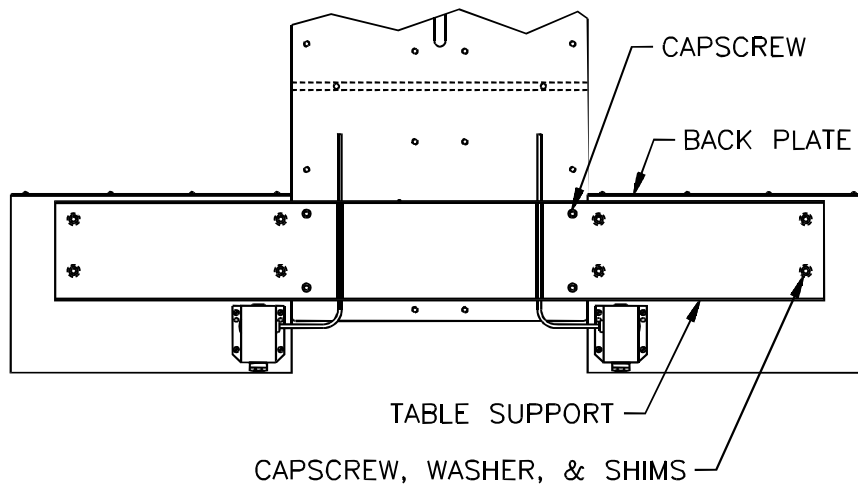

Figure 11

5.6 Hydraulic System Check

The cutting/clamping mechanism of the Titan 200 is powered by a hydraulic system consisting of an electric motor coupled directly to a hydraulic pump.

The hydraulic reservoir holds 4 quarts (1 gallon) of hydraulic fluid. It is filled with Rykon 100 hydraulic fluid at the factory but should be checked before operation. Remove the lower rear panel cover and unscrew the cap on top of the tank (Figure 12 on page 15). Fluid level should be at 1/8" from the end of the dip stick (check with dip stick cap screwed in). Add fluid if necessary but avoid overfilling as this could cause leakage when hot. Replace the rear panel when finished. For more information about checking and changing the hydraulic fluid, including a cross-reference chart of approved fluids, see the Titan200 Technical Service and Parts manual.

The hydraulic fluid should be checked weekly and changed **AT LEAST ONCE-A-YEAR** or after every 1,000 hours of operation.

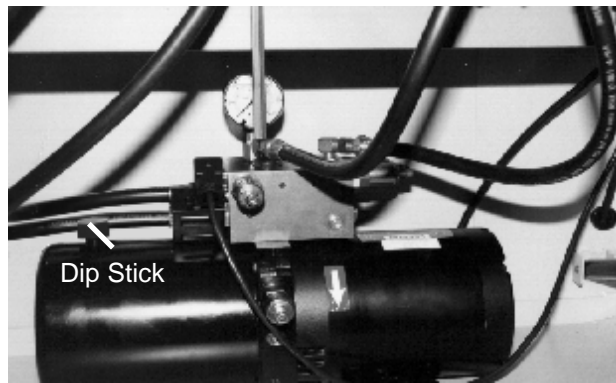

Figure 12

5.7 False Clamp Plate (Optional)

To prevent marking on pressure sensitive jobs, a false clamp plate is available as an optional item for your machine. This plate attaches to the bottom of the clamp. It is secured with wing nuts on studs that pass through the top of the clamp.

To install:

1. Make sure the knife and clamp are in the up position. If they are not, turn on the power using the red and yellow main power switch, close the front guard, and press the CLEAR button. This will preset the backgauge and send the knife and clamp up.
2. Turn the power off and disconnect the power cord.
3. Open the front guard (if equipped) and slide the false clamp plate under the knife and clamp (Figure 13) and slide the plate up into position with the locator pins toward the front of the machine. The locator pins insert into holes in the bottom front of the clamp.
4. Hold the plate in position and secure with the wing nuts provided.
5. Change the false clamp setting of the machine to ON to **prevent the backgauge from crashing into the false clamp plate**. This is done in the Maintenance Mode/Parameters/False Clamp screen. For more details on how to do this, see page 24.

NOTE: The minimum cut with the false clamp plate attached is 1-3/4"

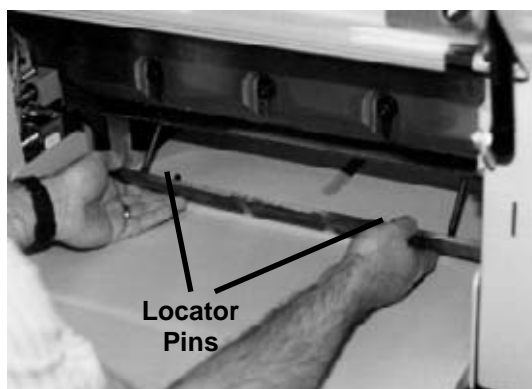

Figure 13

5.8 Power Hook-Up

⚠ CAUTION **SHOCK HAZARD! NEVER CUT THE GROUND PLUG** from a three-prong plug to fit a two-prong socket. Possible shock could cause personal injury or death. Hire a qualified electrician to provide a power source that meets electrical requirements and all local electrical codes.

It is the customer's responsibility to provide a properly grounded receptacle that meets the power requirements specified on the nameplate of this machine, as well as all local electrical codes. Have a qualified electrician install one if your location is not so equipped.

Check incoming voltage and position the voltage selection jumper in the proper location as shown below:

NOTE: The terminal block jumper must be set to the correct location according to the supply voltage of the machine. Failure to set the terminal block jumper will cause damage to the machine!

Connect the power cord into a grounded, 3-prong receptacle only! (Recommended receptacle: 208-230 Volt, NEMA 6-15R, or NEMA 6-20R.)

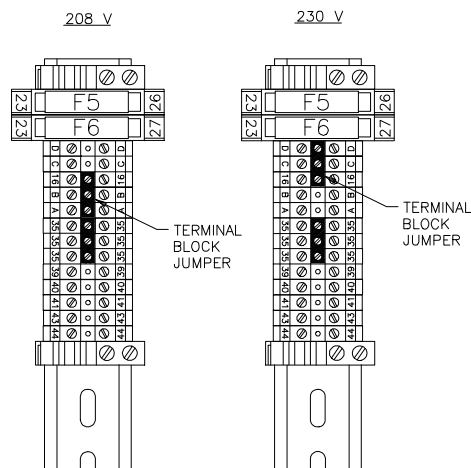

Figure 14

5.9 Line Light

The Titan 200 is equipped with two lights, which provide a line of light on the paper in the approximate location of where the paper will be cut. The lights come on when power to the machine is turned on. The light from each bulb reaches the table after passing between the knife and clamp. Each light is focused with a socket head capscrew (Figure 15 on page 17).

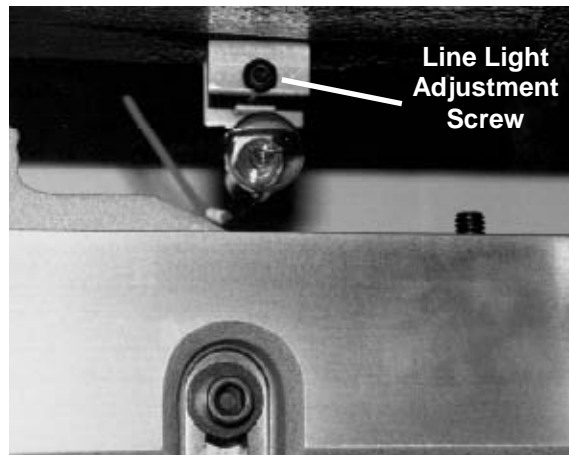

Figure 15

5.9.1 Adjustment

1. Place a wide sheet of paper on the cut stick to view the line light.
2. Using a 3/16" hex allen wrench, turn one of the cap screws until you see a 1/16-1/8" beam. Note: it is best to start by turning the screw clockwise. If the screw turns all the way in before a line appears, begin turning the screw counterclockwise.
3. Similarly, turn the adjustment screw of the other bulb, until one continuous beam is seen across the cut stick.

5.9.2 Bulb Replacement

1. Make sure power is off and unplug the machine (see Power Lockout Procedure, page 5).
2. Open the front guard (if equipped).
3. Remove the old bulb by lightly pushing the bulb into the socket and turning it counterclockwise. **CAUTION!** If the bulb is still hot, allow a few minutes for it to cool.
4. Insert the new bulb into the socket and twist it clockwise until the bulb locks into place.
5. Reconnect power and turn the main power switch on. Readjust the line if necessary.

6.0 Operation

⚠ CAUTION IMPORTANT: DO NOT ATTEMPT TO OPERATE THE CUTTER UNTIL YOU HAVE THOROUGHLY READ AND UNDERSTAND ALL OF THE FOLLOWING INSTRUCTIONS. CALL YOUR AUTHORIZED CHALLENGE DEALER IF YOU STILL HAVE ANY QUESTIONS.

6.1 Power – Main Switch

Power is brought to the machine when the main power switch is turned to the “ON” position (Figure 16). The display and line lights are turned on at this time. The hydraulic motor will not be activated until a cut cycle is initiated, and it will shut off after the completion of the cut cycle.

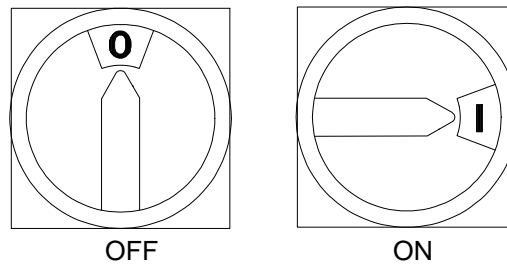
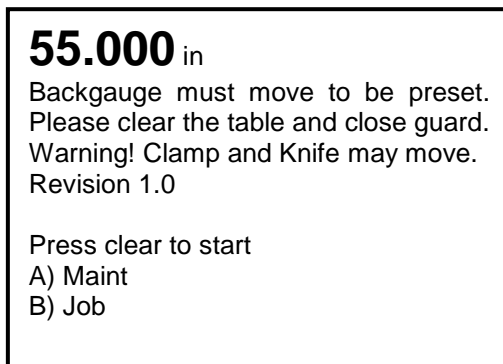

Figure 16 –Power On-Off Switches

The display and line lights will shut off after 5 minutes without any activity. This shut-off time can be changed in the Parameters screen of the Maintenance Mode (section 6.12.2 on page 24). To restore power to the display and line lights, press any button on the keyboard or lift up the front guard (if equipped).

6.2 Start Up

Once power has been turned on, the Titan 200 will show the following display:



When the CLEAR key is pressed the clamp and knife will move up if they are not already in the up position (provided the front guard is closed, if equipped). Then the backgauge will move to coordinate the true position into the computer. When finished, the machine will be in “Send Mode” and the display will appear similar to the display shown on top of the next page.

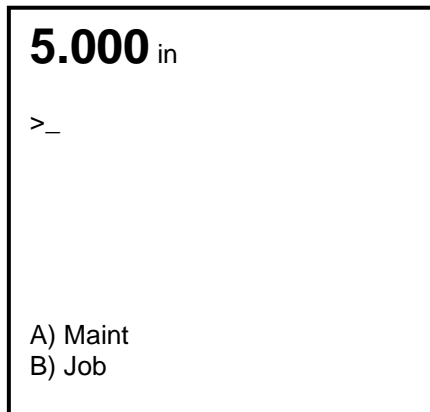

The backgauge may now be sent to a desired position by simply typing the dimension and pressing SEND (see the Send Mode section, page 23, for more details).

6.3 Making a Cut (Machines With Electric Eyes)

Place the paper against the backgauge and left side guide. Note: If the cut will leave strips of paper less than 1/2" wide, place the paper against the right side guide. This will prevent the strips from getting caught in the small opening near the left side guide.

To make a cut, make sure there are no obstructions between the electric eyes, and press both cut buttons (located beneath the front face of the table) within 1/2 second of each other. Hold the buttons in until the knife reaches the table. Releasing the cut buttons at any time during the cut cycle will immediately send the knife and clamp to the "up" position.

6.4 Making a Cut (Machines With Front Guard)

Open the front guard and place the paper against the backgauge and left side guide. Note: if the cut will leave strips of paper less than 1/2" wide, place the paper against the right side guide. This will prevent the strips from getting caught in the small opening near the left side guide.

To make the cut, close the front guard and press both cut buttons (located beneath the front face of the table) within 1/2 second of each other. Hold the buttons in until the knife reaches the table. Releasing the cut buttons or raising the guard at any time during the cut cycle will immediately send the knife and clamp to the "up" position.

Note: The guard must be opened and closed each time a new cut is made.

6.5 Jogging Aid



Always remove the jogging aid from the table before making a cut.

A jogging aid is included as standard equipment with the Titan 200. This tool allows the operator to load and align paper without the need to place hands or arms under the knife or clamp.

To use, load the paper against the side and backgauge using the jogging aid (Figure 17 & Figure 18). Remove the jogging aid from the table, close the guard, and make the cut.

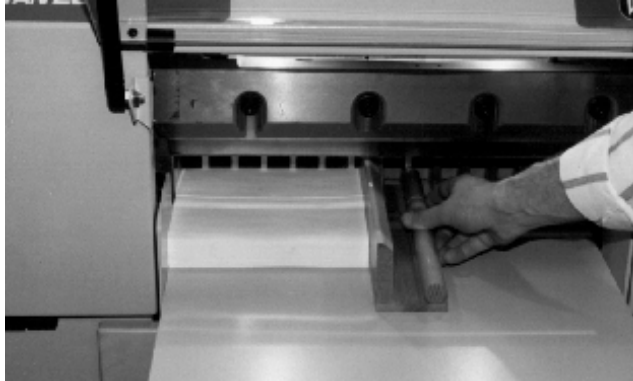

Figure 17



Figure 18

6.6 Knife Change Alarm and Lubrication Alarm

The Titan 200 has two built in alarms that will be displayed after a certain number of cuts. The knife alarm displays a message that notifies the operator to change the knife. The lube alarm displays a message that notifies the operator to have the machine lubricated. The lube alarm will also display the name and phone number of the Challenge dealer from which the machine was purchased. To reset either alarm, or to change the knife alarm value, see 6.12.2.5 Knife Count, page 25.

NOTE: The alarms do not prevent normal operation; they are simply reminders.

6.7 Manual Clamping (Using the Foot Treadle)

The Titan 200 is equipped with a manual clamping feature, which allows the operator to manually clamp paper before beginning the cut cycle. To use this feature, press down on the foot treadle until the clamp comes down on the paper. While holding the foot treadle down, close the guard (if equipped) and press both cut buttons. Release the foot treadle once the cut has been completed.

6.8 Display Panel

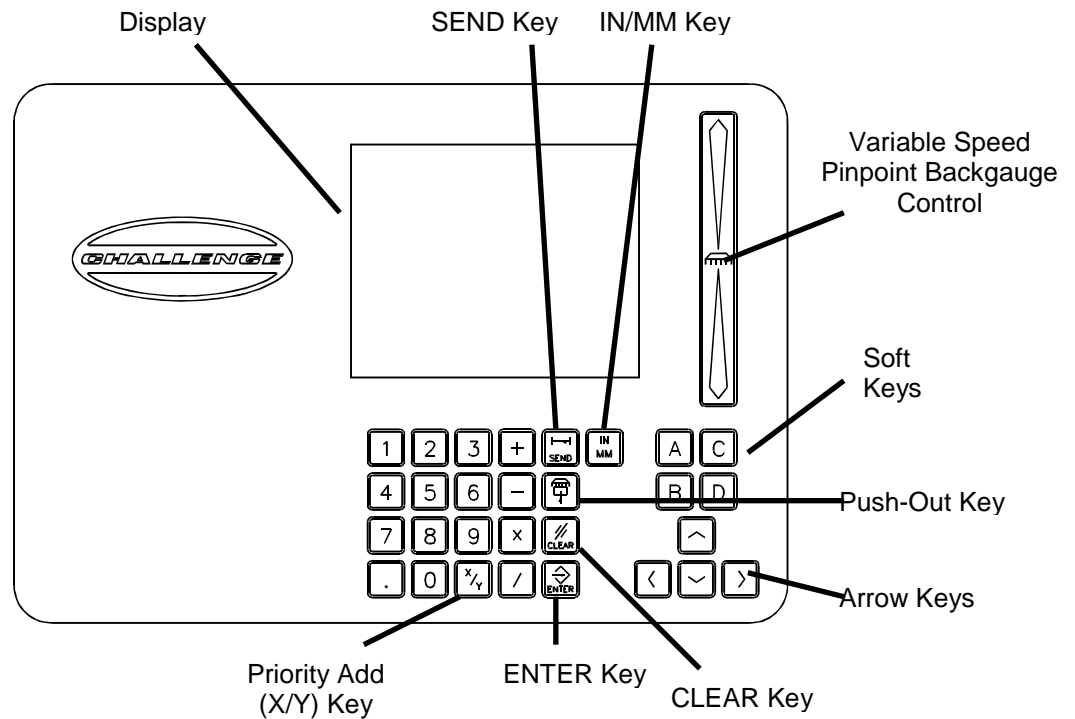

Figure 19

6.9 Definition of Keys

6.9.1 Variable Speed Pinpoint Backgauge Control

The backgauge control is used to manually position the backgauge. The speed of the backgauge will depend upon where the actuator is pressed. Press farther from center for a faster speed. Press toward the operator for forward direction and away from the operator for reverse direction.

6.9.2 IN/MM Key

This key toggles the display to show the position and programmed send values in inches (e.g. 5.250), inch fractions to the nearest 1/64" (e.g. 5_1/4), or millimeters (e.g. 133.3).

6.9.3 Send Key

The SEND key is used to send the backgauge to any valid position. If an attempt is made to send the backgauge to an illegal position, an error message will be displayed at the bottom of the screen stating "Number outside limit". In the Job mode, the SEND key will also advance the backgauge to the next sequential cut position before performing the cut.

6.9.4 Push-Out Key/Hold-To-Run Backgauge Key

This key has 2 functions. It is used to move the backgauge forward 5 inches (or to the most forward position) and then return it to its previous position. This allows paper to be removed from the cutter without putting hands under the knife and clamp. It also allows backgauge to move forward under program control if the electric eyes are blocked (or front guard is raised) for dimensions less than 3.5 inches (8.9 cm).

CAUTION

Never place hands in the clamp and knife area. Use the push-out key or the backgauge glide control to move the paper to an area where it can be reached.

6.9.5 Clear Key

The CLEAR key is used to clear error messages and the current entry line.

6.9.6 Enter Key

The ENTER key selects items in the maintenance mode and processes data that has been entered in the other modes.

6.9.7 Priority Add (X/Y) Key

The priority add key is used for entering fractions when they are combined with whole numbers. The symbol displayed when this key is pressed is the underline symbol “_”. An example of a number entered using the priority add key is 1_1/2 (see 6.11.2 Entering Fractions, page 24).

6.9.8 Soft-Keys

The soft-keys are labeled as A, B, C, and D. The definition for these keys change depending on the operating mode. The function of the key can be found on the bottom of the display screen.

6.9.9 Arrow Keys

The four arrow keys can be used in almost all screens. The arrow keys are primarily used for moving the cursor around on the screen, or to toggle between highlighted selections. In some screens, the left arrow key acts as a backspace key.

6.9.10 Contrast Control (Serial Numbers 083330 and Below)

The contrast of the display can be adjusted by using the contrast control knob, which is located directly behind the display panel, sticking out of the display panel cover. To access, open the front guard, reach in with your left hand until you feel the knob, and adjust the contrast as necessary.

6.9.11 Contrast Control (Serial Numbers 083331 and Above)

The contrast of the display can be adjusted by first pressing the hidden button on the control console face plate and then using the left or right arrow buttons, press as needed to fine tune the screen's contrast.

6.10 Manual Backgauge Control

6.10.1 Backgauge Glide Control

The backgauge can be moved manually by use of the backgauge glide control. Press towards the operator for forward travel and away from the operator for reverse travel. The further away from center that the actuator is pushed, the faster the backgauge will travel.

6.10.2 Backlash Indicator

To insure accurate cuts, the backgauge must be brought to the cut position from the rear of the table. In the display, to the right of the backgauge position, there is a small arrow to indicate reverse travel (Figure 20). This arrow should be off when making a cut. Moving back past your cut position, then forward to it, compensates for any play in the backgauge nut and leadscrew.

6.11 Send Mode

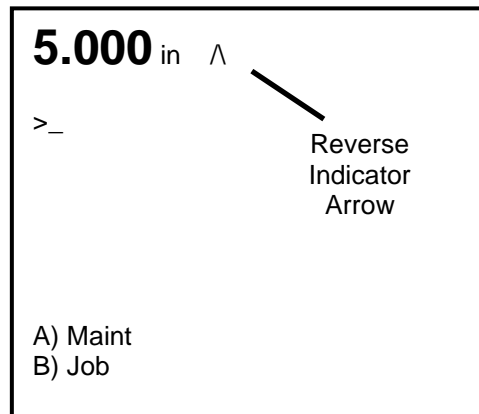

Figure 20

The send mode is the first screen displayed after the backgauge is preset. From this screen the backgauge can be positioned with the backgauge pinpoint control or by entering a value and pressing the SEND key. If the send value is less than approximately 4", either the hood must remain down or the push out button held in, for the backgauge to continue to the send position. A mathematical expression can also be entered as a send value. Simply type the expression and press SEND. You can also enter an equation, which begins with the current backgauge position. For example, if you want to send the backgauge 2" forward from its current position, just press [-] [2] and SEND.

The send mode screen can also be used for doing math calculations that are larger than the backgauge's reverse limit. In this case, you must press ENTER to have the result displayed on the screen.

6.11.1 Entering Math

In the simple send mode, the Titan 200 is capable of calculating an entire math string such as, $10-5+5 \times 6+2 \frac{3}{4}$. However, the result is limited to 29999.000 and the result cannot be a negative value. In the job mode, and during a send, the result of the calculation must be less than the backgauge limit of 20.000 inches.

6.11.2 Entering Fractions

Fractions are entered with the priority add key X/Y. The symbol displayed when this key is pressed is the underline symbol “_”. This instructs the computer to add the fractional portion of the entry before performing the remaining math. This key is useful when entering a formula as follows: $3 \times 2_3/4 = 8_1/4$. If a simple plus had been used instead, the result would be as follows: $3 \times 2 + 3/4 = 6_3/4$.

6.12 Maintenance Mode

The maintenance mode is an area where many machine functions can be set or modified. The four principle functions are: Language, Parameters, Diagnostic, and Knife Adjust. From the Send Screen, (Figure 20 on page 23), enter “A” to go to the Maintenance Screen. To select a particular function, use the up and down arrow keys to toggle to the desired function and press ENTER. See the following descriptions for an explanation of each function.

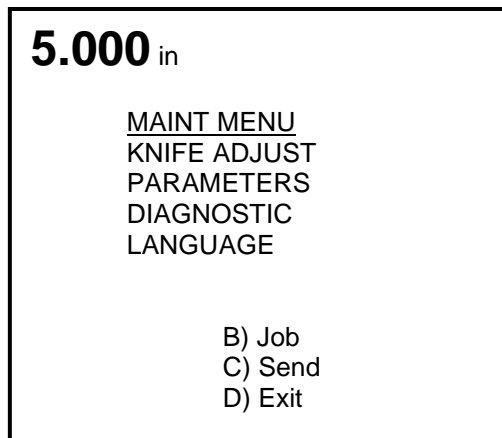

6.12.1 Knife Adjust

The knife adjust function provides a way for the service technician to adjust/change the knife. In the Knife Adjust screen, use the up and down arrow keys to toggle to the up or down status as desired, and press ENTER. Close the front guard(if equipped) and press the cut buttons to send the knife to the desired position (in the down mode, hold the cut buttons until the motor turns off).

NOTE: To exit the knife down screen and return to the main menu screen, press “D” exit.

6.12.2 Parameters

In the parameter screen, use the up and down arrow keys to toggle to the desired parameter, and press ENTER. See the descriptions that follow for an explanation of each parameter.

6.12.2.1 False Clamp

The false clamp plate is an optional attachment, which reduces the creasing of paper caused by the clamp. The disadvantage of using the false clamp plate is that it limits the smallest cut dimension. **The computer must know when the false clamp plate is installed on the machine to prevent the backgauge from crashing into it.** In the false clamp screen, use the up and down arrow keys to toggle between ON or OFF to indicate the presence of the false clamp plate, and press ENTER.

6.12.2.2 Time-out

The time-out parameter allows the operator to set the amount of idle time before the display and line lights turn off. The choices are 2, 5, 10, 20, and 30 minutes. In the time-out screen, use the up and down arrow keys to toggle to the desired time-out, and press ENTER.

6.12.2.3 Push-out

Normally, whenever the backgauge is sent to a larger dimension, a five-inch (127mm) push-out is performed to aid the operator in accessing the paper. In some situations, it may be necessary to turn this feature off. It is recommended that this feature be left on whenever possible. In the push-out screen, use the up and down arrow keys to toggle to the on or off status as desired, and press ENTER.

6.12.2.4 Accuracy Adjust

This parameter provides a means for adjusting the accuracy of the backgauge. To change the accuracy, send the backgauge to 2 inches (50.8mm) and cut some paper. Measure the paper, and type in what you actually measure. The computer will calculate the amount of error and will compensate.

6.12.2.5 Knife Count

The knife count parameter allows the operator to reset the knife alarm and the lube alarm. The knife alarm displays a message that notifies the operator to change the knife. The lube alarm displays a message that notifies the operator to have the machine lubricated. The lube alarm will also display the name and phone number of the Challenge dealer from which the machine was purchased.

NOTE: The alarms do not prevent normal operation they are simply reminders.

There are three functions within the knife count parameter: Clear Count, Knife Alarm, and Clear Lube. Select the desired function and press ENTER. See the following descriptions for an explanation of each function.

Select **Clear count** to reset the knife counter when a knife change has been performed.

Select **Knife Alarm** to enter or change the knife stroke alarm value. When this value is reached, the display will alert you to change the knife and reset the knife counter. Knife alarm values for the Titan 200 are factory set at 2,500 cuts. However, you may want to change this value based on your specific machine applications. See 7.3 Knife Care Tips, page 36 for help in choosing a knife alarm value for your machine.

Select **Clear lube** to reset the lube alarm after performing the lubrication requirements as shown in the Titan 200 Technical Service and Parts manual. Note: The number of cuts needed to set off the alarm is programmed at the factory and cannot be changed.

6.12.2.6 Machine count

The number displayed is the total number of cuts made by the machine.

6.12.3 Diagnostic

The diagnostic area can be very helpful in locating a problem in the event of a machine malfunction. Use the up and down arrow keys to toggle to the desired selection, and press ENTER. See the following descriptions for an explanation of each.

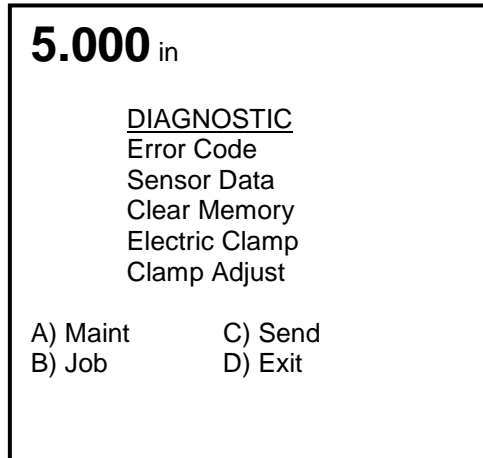

6.12.3.1 Error Code

The Error Code function simply recalls the last five error messages that were displayed. This can be very useful in cases when the malfunction cannot be reproduced in the presence of the service technician.

6.12.3.2 Sensor Data

The Sensor Data function provides a list of computer inputs and outputs (proximity switches, etc.) along with their status (0 for open, 1 for closed). This function allows a service technician to check the status of a switch without removing any covers. Cuts and backgauge movements are allowed in this screen so that the technician may observe the status of the inputs and outputs during machine operation.

6.12.3.3 Clear Memory

The Clear Memory function resets the memory to a known state. **All cut positions will be erased during this operation.**

6.12.3.4 Electric Clamp

This function turns the optional electric clamp pressure control on or off.

6.12.3.5 Clamp Adjust

This function allows for the adjustment of the electric clamp function.

6.12.4 Language

In the language screen, use the up and down arrow keys to toggle to the desired language, and press ENTER. All messages will be displayed in the selected language.

6.13 Job Mode

The Titan 200 can be programmed for up to 99 different jobs or channels. A job is used for making a sequence of cuts using the send (or cut) values of the job as the backgauge positions for each cut. Each job can hold up to 99 send values. If 2 channels are linked, up to 198 send values can be accessed from one job. When the job mode is entered, all previously programmed jobs will be displayed along with their name and lock status. Locked jobs will be indicated by an asterisk "**". A plus "+" sign at the bottom of the screen indicates there are more jobs programmed than what are displayed. An example of a job mode screen display is shown below.

```

>

1≥ JOB 1
2> TESTJOB
5>
6> BOBS JOB *
7> 8.5 X 11 *
9>
10>
+
A) Lock          C) Erase
B) Copy         D) Exit

```

6.13.1 Lock/Unlocking a Job

In the Job Mode screen, the soft-key "A" will display "Lock" or "Unlock" depending on the current status of the job. If a job is locked, an asterisk "*" will be displayed to the right of the job name. To change the lock status of a job, simply move the cursor to the desired job using the up and down arrow keys, and press the soft-key "A" (Lock/Unlock).

6.13.2 Copying a Job

First, select a job to copy by moving the cursor up or down to the desired job number and press the soft-key "B" (Copy). "Select Copy to #" will be displayed at the bottom of the screen. Enter a job number for the new job or move the cursor to an existing job and press ENTER. If the new job is locked, the copy will not be allowed. NOTE: if the new job is not locked, but contains data, the old data WILL BE LOST.

6.13.3 Erasing a Job

Select a job to erase by moving the cursor to the desired job. Press the soft-key "C" (Erase). "Clear channel #" will be displayed, followed by YES or NO. Use the up and down arrow keys to toggle to YES or NO. YES will erase the job, NO will leave the job unchanged. NOTE: locked jobs can be erased!

6.13.4 Creating a New Job

To create a new job, type in a number that is not already assigned to a job and press ENTER (entering a job number greater than 99 will create job #99). The cursor will move to the line corresponding to the number you typed in, prompting you for a job name. If no job name is desired, simply press ENTER again to begin entering send values (see below). To name the job, press the right arrow key to move the cursor to the first character position. Enter a character of the alphabet by using the up and down arrow keys to toggle to the desired character. The numeric keys can be used to enter numbers directly into the job name. When the desired character is in place, use the right arrow key to move to the next character position. The job name can be up to 10 characters long. A letter can be removed from the job name by moving the cursor to the undesired character and pressing the CLEAR key. When finished, press ENTER to save the name and to begin entering send values. The screen should now look similar to the one shown next:

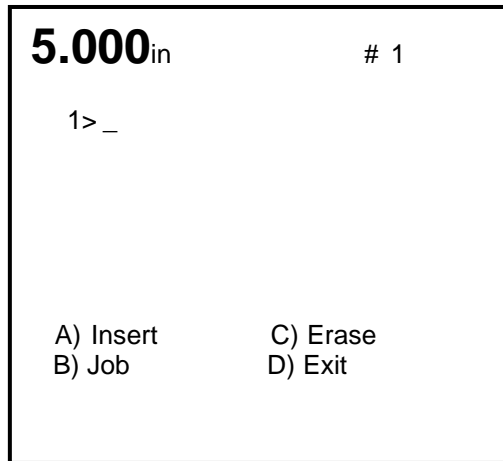

6.13.4.1 Entering Send Values

Now enter send values by using any of the following methods: 1) Type in the desired value and press ENTER, 2) Press ENTER at a blank line - this will enter the current position of the backgauge as a send value, or 3) Use the "Cut and Record" feature as described below.

When finished entering send values you may exit the current job by pressing soft-key "B" (Job) to go back to the job mode screen or soft-key "D" (Exit) to exit to send mode. Or you may use the current job for cutting by pressing the down arrow at the last line and following the instructions in the "Running a Job" section (page 30).

6.13.4.2 Cut and Record

To use this feature, send the backgauge to a desired position using the backgauge glide control or by using SEND, then make a cut. The current backgauge position will automatically be entered into the job as a send value. This can be very convenient for setting up a program when the actual cut positions are not known.

6.13.4.3 Channel Linking

If more than 99 cut values are needed, 2 channels can be linked together into one job providing up to 198 cut values. This is done automatically when a job is at 99 cuts and an attempt is made to add another value. At this point, a screen is displayed asking: do you want to link to the next channel? Use the up or down arrow key to select yes or no. If no is selected, the last cut will be discarded and

the new value will be inserted. If yes is selected, the last cut will be pushed into the first value of the next channel, although it will be displayed as value 100 of the current channel. If the next channel is locked, linking will not be allowed. NOTE: If the next channel is not locked, but contains data, the old data WILL BE LOST. After 2 jobs have been linked, the linked job will be displayed as “~~~~~” and will be locked.

To unlink a job, use the up or down arrow key to point to the linked job name and press soft-key “C” (Erase).

When finished entering send values you may exit the current job by pressing soft-key “B” (Job) to go back to the job mode screen or soft-key “D” (Exit) to exit to send mode. Or you may use the current job for cutting by pressing the down arrow at the last line and following the instructions in the Running a Programmed Job section 6.13.6 below.

6.13.5 Editing an Existing Job

6.13.5.1 Editing the Job Name

The job name can be edited (or added if an existing job does not have a name) in the job mode screen. To edit the name, move the cursor down to the desired job number by pressing the down arrow key. Then press the right arrow key to move the cursor to the desired character position and edit the character by pressing the up or down arrow keys to toggle between characters of the alphabet. Numbers can be entered directly by using the number keys. Pressing CLEAR clears the current character. When finished, you may either go to the current job by pressing ENTER, or go to a different job, or exit job mode.

6.13.5.2 Editing Send Values

To edit send values of an existing job, start by opening the desired job from the job mode screen. A job is opened by one of two methods: pointing at the desired job with the cursor and pressing ENTER, or by entering the job number with the keypad and pressing ENTER. Once a job has been opened, the current job number will be displayed in the upper right corner. Note: If the job is locked, it cannot be edited.

Send values can now be edited by moving the cursor up or down to the desired send value and then typing over the existing value.

When finished editing the job, you may exit the current job by pressing soft-key “B” (Job) to go back to the job mode screen or soft-key “D” (Exit) to exit to send mode. Or you may use the job for cutting since it is already open.

6.13.5.3 Inserting Send Values

To insert a send value, press the soft-key “A” (Insert). This moves all send values down and provides a blank line after the current send value. If more than 99 send values are needed, the job can be linked (see Channel Linking under the Creating a New Job section on page 28).

6.13.5.4 Erasing Send Values

To erase a send value, press the soft-key “C” (Erase). This will remove the cut value currently being pointed to by the cursor. To backspace over the current send value without removing the line, press the left arrow key.

6.13.6 Running a Programmed Job

To use an existing job for cutting, you must first open it by using one of two methods: move the cursor to the desired job with the arrow keys and press ENTER, or enter the job number with the keypad and press ENTER. Once a job has been opened, the current job number will be displayed in the upper right corner. Now press SEND to move the backgauge to the first programmed position (or send value). Close the front guard and make a cut. Once the cut is made, the backgauge will automatically push out the paper (if “push-out” is enabled) and move to the next programmed position. After the last cut in the job is made, the backgauge will move to the first cut position of the current job. Pressing SEND at any time during the job will send the backgauge to its next programmed position without making a cut. A plus “+” sign will be displayed at the bottom of the screen if more cuts remain in the current job.

6.13.7 Exiting a Job

To exit an open job, press the soft-key “B” (Job) to return to the job mode screen, or press the soft-key “D” (Exit) to exit to the send mode screen.

6.14 An Example Job

The following is an example of how to program a job, which will be used to make two cuts: one at 8.5” and one at 11”.

1. Turn on the machine and press CLEAR to preset the backgauge. Press the soft-key “B” (Job) to go to job mode.
2. Type in a new job number and press ENTER. Note: It must be a number that does not correspond to an existing job. All existing jobs will be displayed on the screen (you may have to scroll through them to see them all). If you wish to replace an existing job with the new job, first erase the existing job by moving the cursor to it and press the soft-key “C” (Erase). Now type in the new number and press ENTER. In this example, job #'s 1, 2, 5, and 6 already exist. We will use job # 7 for our new job. Press “7” and ENTER.
3. The cursor will move down to the new job number. At this point, press the right arrow key once to move the cursor to the first character position. Now name the job “8.5 X 11”. To do this, press “8” on the number keypad. Then press the decimal “.” key and so on. To enter the spaces and the letter “X”, use the up and down arrow keys to toggle through the alphabet and press the right arrow key to move to the next character position. When the last character has been typed in, the display should look similar to the one shown below:

```
>  
  
1≥ JOB 1  
2> TESTJOB  
5> BOBS JOB *  
6>  
7> 8.5 X 11_  
  
+  
A) Lock          C) Erase  
B) Copy          D) Exit
```

Now press ENTER to begin programming the job. The display should now look similar to the one shown next:

5.000 in	# 7
1> _	
A) Insert	C) Erase
B) Job	D) Exit

- To enter the first send value of 8.5", simply type in 8.5 and press ENTER. The cursor will move to the second line. Now type 11 and press enter.

5.000 in	# 7
1> 8.500	
2> 11.000	
3> _	
A) Insert	C) Erase
B) Job	D) Exit

At this point, you could exit and save the job by pressing the soft-key "D" (Exit) to exit to send mode, or the soft-key "B" (Job) to exit back to the job mode screen. However, lets use this job to cut paper.

- Press the down arrow key once. This will remove the blank line 3 and move the cursor to the first send value (8.5"). Now press SEND. This will move the backgauge to the 8.5" position. Place the paper to be cut against the backgauge, close the front guard, and press the cut button. Once the cut cycle is complete, the backgauge will push out the paper and move to the next send value (11"). Now position the paper again, close the guard, and make another cut. After the cut is

made, the backgauge will push out the stock and return to the first cut position, ready to repeat the current job.

6. Now lets lock the current job so it cannot be edited. First, exit back to job mode by pressing soft-key "B" (Job). Now move the cursor down to the new job using the down arrow key. Now press the soft-key "A" (Lock) to lock the job. An asterisk will appear indicating the job has been locked.
7. To exit back to send mode, press the soft-key "D" (Exit).

6.15 Operating Tips

Carefully lay out each sheet before you start cutting. Find the best cut pattern to give you the most pieces out of the sheet. If the sheet will be folded, be sure grain of the paper is running in the same direction as the fold or you will get a rough edge on the fold.

If an accurate cut is necessary for close register work, you **MUST** have a sharp blade in the cutter. A dull blade will pull or draw the paper and cause uneven cutting. Increased clamp pressure will not eliminate draw caused by a dull knife.

The correct clamping pressure varies from paper to paper. The general rule is that you should have enough pressure to hold the paper securely but not so much that it marks the surface of the paper excessively. Excessive pressure causes pile distortion and inaccurate cuts.

Mark the gripper edge and the guide edge of printed paper and make sure the first cuts are with these guide edges against the backgauge.

Measure printed paper to check for shrinkage or expansion of the paper from humidity. You may have to disregard the printed cut lines and make your own.

When cutting business cards or narrow strips of paper, place lifts of equal height on opposite sides of the table to prevent wear of the clamp guides.

6.16 Note to Dealer

6.16.1 Entering the Dealer Name and Phone Number

To enter or change the dealer name and phone number that will be displayed when the lubrication alarm is displayed and when the upgrade screen is displayed, you must first enter the "Dealer Mode" screen. To do this, turn off the power and then simultaneously hold the left and right arrow keys while turning on the power. Continue to hold the arrow keys for a few seconds after the machine turns on. Now enter the desired dealer information by using the up and down arrow keys to toggle through the characters (similar to naming a job). Use the right arrow key to move to the next character and to move to the 2nd line. When finished, turn off the power.

7.0 Knife Installation/Changing

⚠ CAUTION

Changing knives can be very dangerous unless safety precautions are observed and extreme care is taken when handling knives.

- Make sure knife lifters are properly installed, see instructions following.
- Keep handling of unprotected knives to an absolute minimum.
- Clear off cutter table before removing knife.
- Have scabbard on cutter table and insert knife immediately.
- Warn people of any unprotected knife.
- Knife changing is a **ONE PERSON OPERATION**. Having more than one person trying to change knives invites accidents.

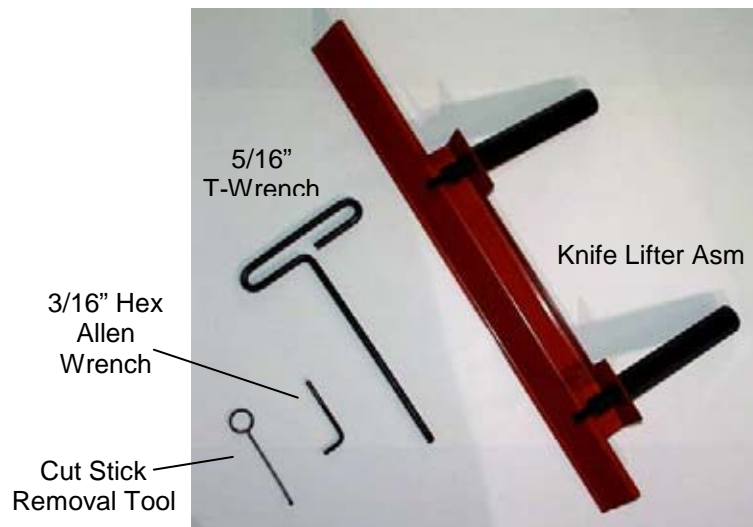

Figure 21 – Knife Changing Equipment

The knife changing equipment shown in Figure 21 is included in the cutter tool kit. The following instructions show how to remove and install a new or re-sharpened knife. Read through these instructions **AT LEAST ONCE** before attempting to actually change or install any blades.

7.1 Knife Removal

1. Make sure the knife and clamp are in the “up” position. Turn the main power switch to the “OFF” position and disconnect the machine power cord to prevent accidental power-up while servicing the cutter.
2. Back off the knife adjusting screws on top of the knife bar several turns (Figure 22). A new knife will cut deeper than one that has been ground several times. Failure to back off the screws could damage the knife and/or the cutting stick.

7.0 Knife Installation/Changing

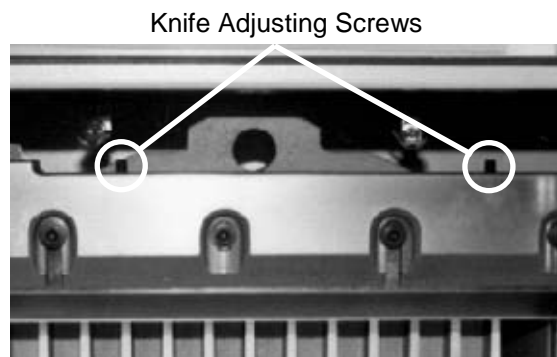

Figure 22

3. Remove the knife bolts from the two slotted knife bar holes and replace with the knife lifter assembly (Figure 23). Tighten the lifters to hold the knife in place, and then remove the remaining two knife bolts.



Figure 23

4. Clear the table surfaces and place the empty knife scabbard on the table. Remove the scabbard's knife retaining screws.
5. Grasp the knife lifters firmly and, at the same time, turn them counterclockwise to release the knife from the knife bar (Figure 24). Lower the left end first, then lower the right end as you shift the knife sideways to the left. Bring the right end of the knife around the knife bar guide frame. Maneuver the right end into the space between the guide frame and the shroud as the left end is brought clear of the left guide frame. Move the knife to the right then bring the knife out of the cutter, left end first. Put the blade in the scabbard immediately and secure the knife retainer screws.



Figure 24

7.2 Knife Installation



Knives are heavy and always very sharp! Be sure to keep the edge away from your body and keep other people out of the area while handling the blade. Severe lacerations or dismemberment could result from careless handling procedures.

1. Make sure the knife and clamp are in the up position. If they are not, turn on the power using the red and yellow main power switch, close the front guard (if equipped), and press the CLEAR button. This will preset the backgauge and send the knife and clamp up.
2. Turn off the machine and unplug the power cord.
3. Pull out the cutting stick using the cut stick removal tool and turn it to a new surface. If the cutting stick is not level or flush with the table, 1/2" strips of paper can be placed in the table slot under the cutting stick to shim it.
4. Remove the left retainer screw from the new blade and screw the knife lifter assembly into the new blade. Screw the lifters all the way in and then back them out a 3/4 turn).
5. Remove the other scabbard retainer screw.
6. Double check to make sure the knife adjusting screws have been backed out all the way (step #2, Knife removal). Lift the blade and insert it into the knife bar slot. Guide the blade, right edge first, into the space between the shroud and the knife bar guide frames. Tip to clear the table side guides, then move the left end of the blade into the knife bar slot dropping the left end as the right end is brought around the right knife bar guide frame and up into the knife bar slot. Raise the knife into the knife bar slot as high as it will go and tighten the lifters.

NOTE: If the blade will not go in, either the lifters are screwed into the blade too far, or the end of the blade is hitting the cylinder bracket at the right end of the knife slot. In this case, drop the left end when inserting the knife.

7. Insert the knife bolts with washers and snug to hold the knife, but don't tighten them yet.
8. Remove the knife lifter assembly and replace with bolts and washers.
9. Place a few sheets of paper over the cut stick, covering the stick end-to-end.
10. Plug in the power cord and turn the power on.
11. Go to the MAINTENANCE screen and choose KNIFE ADJUST. Choose KNIFE DOWN, close the guard (if equipped) and press the cut buttons to send the knife to the down position, hold the cut buttons until the motor turns off (for more details on how to do this, see page 24, Knife Adjustment).
12. Turn the power off and disconnect the machine power cord.
13. Turn the knife adjusters down evenly, a little at a time, until the knife cuts through the bottom sheet of paper the entire length of the cutting stick (Figure 25). Turning the screws down evenly prevents uneven wear on the knife and cutting stick.

7.0 Knife Installation/Changing

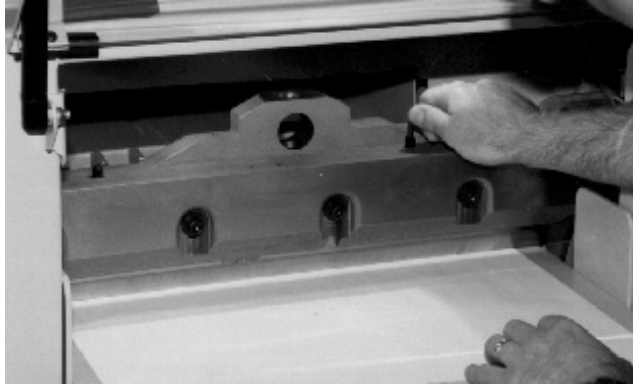

Figure 25

14. Plug in the power cord and turn the power on.
15. Close the front guard (if equipped) and press CLEAR. This will raise the knife and clamp to the up position.
16. Turn the power off and disconnect the machine power cord.
17. Tighten all knife bolts securely.
18. Plug in the power cord and turn the power on. Make a test cut through a full lift of paper and make minor adjustments if necessary by repeating steps 9 through 17. **NOTE:** If the knife ends cut but the middle doesn't, you could have dips or uneven spots in the knife and/or cutting stick. These can be eliminated by placing 1/2" strips of paper in the table slot beneath the cutting stick to shim it.
19. Send the dull knife to a knife grinder. Do not attempt to sharpen your own knives! See the Knife Care Tips Section below to determine the knife bevel angle.

7.3 Knife Care Tips

⚠ CAUTION ! KNIFE SAFETY ! Knives are **DANGEROUS!!!** They are heavy and very sharp, even after use. Keep the edge away from your body and keep the area clear of others when handling knives. Never touch the cutting edge! To prevent personal injury and damage to the knife, always keep knives in their holders with screws tightened. You are aware of the dangers, but others may not be. Never attempt to hone, polish, or service the knife in any way. Failure to follow safety procedures may result in severe lacerations or dismemberment.

7.3.1 Knife Blade Life

Knife blade life, or the time between sharpenings, can be affected by many factors. One important factor is the type of paper being cut. Abrasive paper, such as recycled paper, soft paper such as newsprint paper, and bound books can all significantly shorten knife blade life. Also, if the knife depth is set too deep, the knife will cut too deep into the cutting stick and can dull the knife blade.

A knife can last between 2,000 and 5,000 cuts before it needs to be sharpened. Cutting soft paper (such as newsprint paper) or paper with high post-consumer recycled content can cause the knife to need sharpening after only 2,000 to 3,000 cuts. Cutting pure paper, such as bond paper with no recycled content, or hard paper can allow the knife to be used for as many as 5,000 cuts before it needs to be sharpened. In all cases, the operator should continually check the quality of the cut to

determine when the knife blade needs to be sharpened. Some characteristics that indicate a blade needs sharpening are:

- The knife hesitates or stalls while making a cut.
- The sheets are not all cut to the same length (usually the top few sheets are longer than the rest of the sheets - this is sometimes called “draw”).
- Cut marks appear on the cut face of the paper.
- The profile of the cut (side view) is not perpendicular to the table.
- The cut does not appear straight when viewed from the top.
- The knife makes a “rougher” sound as it passes through paper.
- Nicks are visible on the cutting edge of the knife.

7.3.2 Cutting Stick

A worn cutting stick can affect the cut quality of the bottom sheets. When this happens, the cut stick can be rotated. Usually, the stick should be rotated one or two times between knife sharpenings.

There are 8 possible cut stick positions. The stick can be rotated 4 times, and then turned end to end, and rotated 4 times again.

7.3.3 Bevel Angle

Challenge recommends that bevel angles for the Titan 200 knives be in the range of 21° to 23°. In general, a 21° bevel angle will provide better cut quality when cutting soft paper (such as newsprint), recycled paper, or bound books. However, 21° angle knives can become dull sooner than 23° knives, which results in shorter knife blade life. A knife with a 23° bevel angle, on the other hand, will not dull as easily, and can provide satisfactory results when cutting most types of paper. Knives shipped with the Titan 200 from the factory have a bevel angle of 23°.

7.3.4 Helpful Suggestions

- If your establishment is large enough to purchase more than one set of knives, have one set beveled at 21° and the other at 23°. Note: A set consists of 3 knives: one in the machine, one as a back up, and one at the grinder.
- If the machine seems to strain but the cut quality is still good, reduce the pile height. You may also carefully apply glycerin to the bevel when cutting hard, coated paper. Tie a cloth to the end of a stick; dip the stick in glycerin, and apply. Never apply by hand! In lieu of glycerin you may lightly rub white bar soap along the bevel. Lubrication will prolong the life of your machine and reduce maintenance.

7.3.5 Knife Care

- To prevent corrosion, knives are coated with light oil. It should be REMOVED WITH CARE.
- While removing or installing a knife, be careful not to allow the edge to bump against the machine. Nicks will result.

7.0 Knife Installation/Changing

- If a knife bolt is damaged, replace it.
- Always keep knife bolts securely tightened.
- Always use the heavy duty knife bolt washers provided by Challenge. Failure to do so could result in scratching or marring of the clamp face.
- Store knives in a dry environment to prevent corrosion.
- Never attempt to service a knife in any way.

NOTES:

8.0 Oil and Grease

Turn the power off and disconnect the power cord. Open the front guard (if equipped) and open the top hood for access. Parts requiring oiling are marked with red paint. See figures Figure 26 through Figure 33 starting on page 40 for oil and grease locations. Figure 26 through Figure 28 require the knife and clamp be in the up position. Figure 29 through Figure 33 require the knife and clamp be down. Wipe off any old or excess grease. Use any brand-name type of grease or light oil to lubricate. It may be necessary to use the supplied grease brush to access some locations. Note: the leadscrew may be lubricated with grease or oil. Oil has a tendency to run off and must be lubricated more frequently; grease tends to collect paper dust and must be cleaned off periodically.

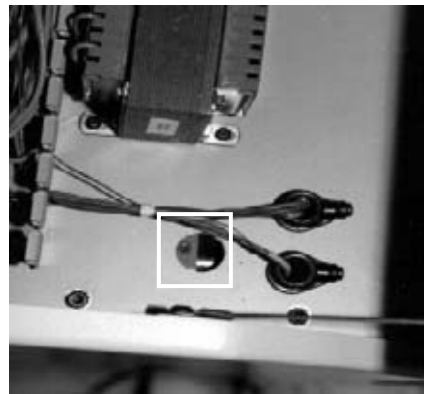
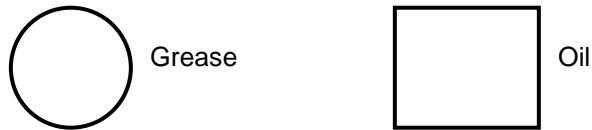

Figure 26 – Knife Bar Link – L.H. Side, Upper

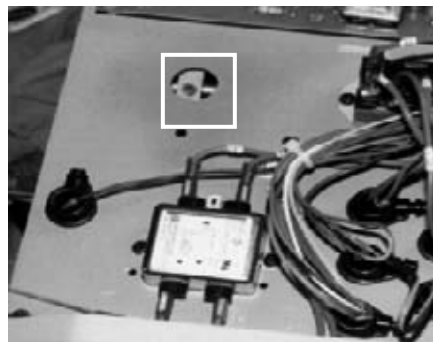

Figure 27 – Knife Bar Link – R.H. Side, Upper

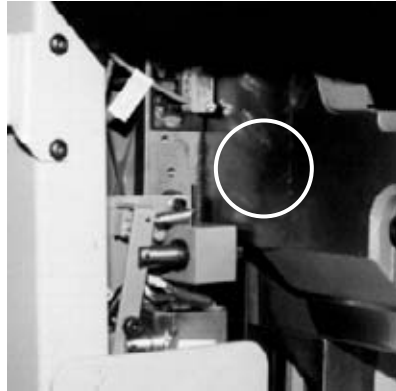

Figure 28 – Knife Bar



Figure 29 – Knife Bar Link – L.H. Side, Lower

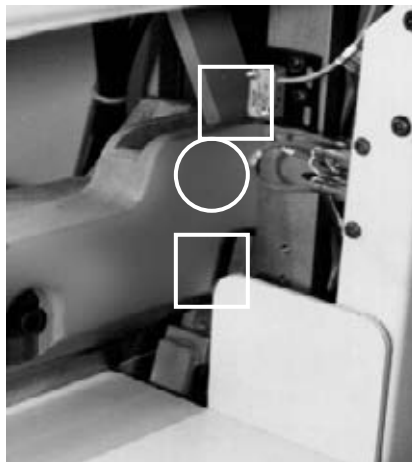

Figure 30 – Knife Bar Link – R.S., Lower

Knife Bar
Knife Cylinder Bracket, Upper

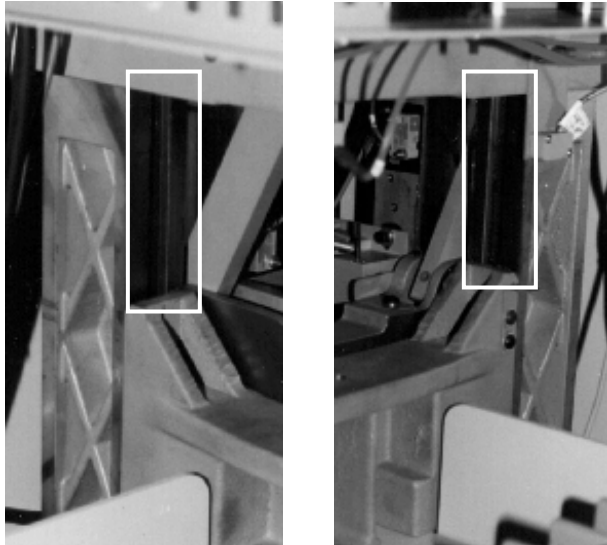

Figure 31 & Figure 32 –Clamp Guides

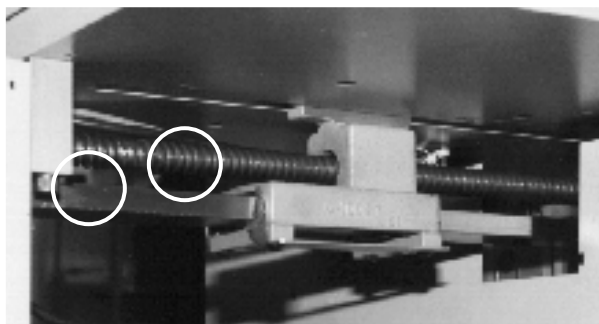
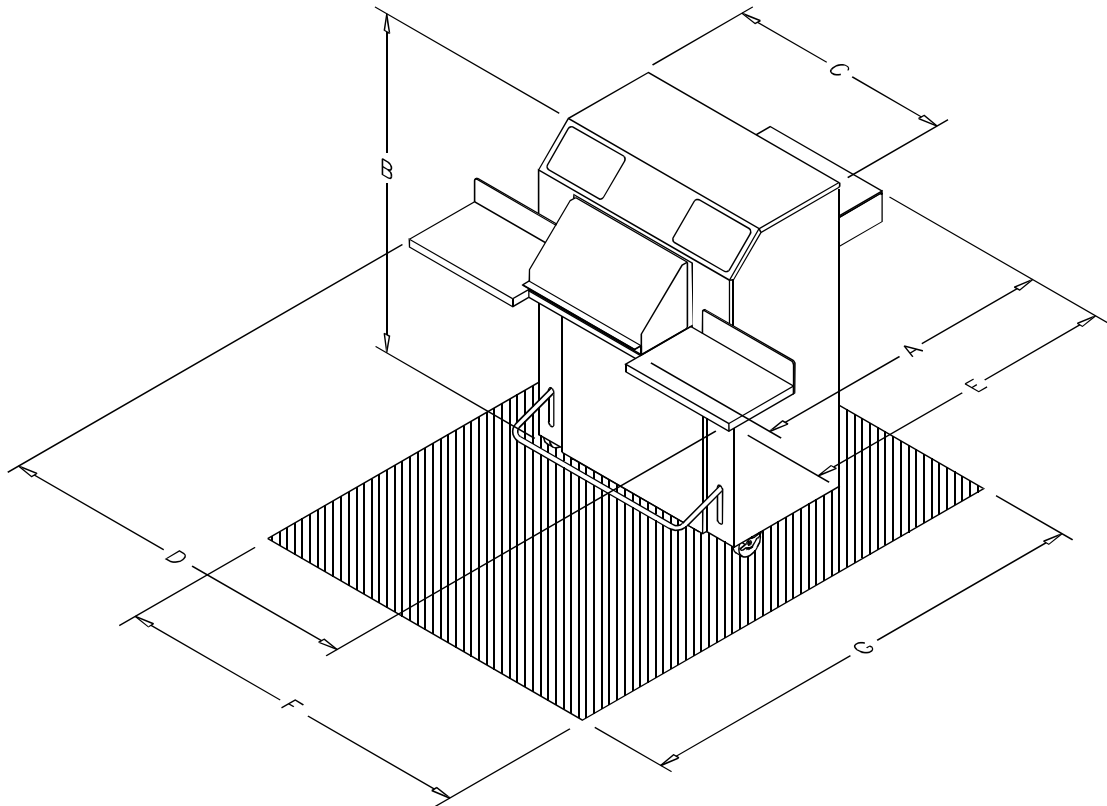

Figure 33 – Leadscrew and Backgauge Guide

9.0 Titan 200 Floor Plan

43000-FP



Symbol	Inch	cm
A	49.0	124
B	53.0	135
C	36.0	91
D	58.0	147
E	53.0	135
F	58.0	147
G	74.0	188
Net Wt.	755 lb	342 kg

MACHINE DIMENSIONS: AxBxC

MACHINE DIMENSIONS WITH SIDE
TABLE EXTENTIONS: DxBxE

OPERATING AREA: FxG

OVERALL MAINTENANCE AREA: FxG

10.0 Safety Systems Test

Machine manufacturer CHALLENGE

Model TITAN 200

Serial Number _____

Frequency of test: **THESE TESTS SHOULD BE PERFORMED AT THE BEGINNING OF EACH WORK DAY.**

Turn the power on and press CLEAR to preset the backgauge. Make sure the knife and clamp are in the up position (if they are not, follow the instructions in this manual to send them up).

Machines with Front Guards:

Test #1: With the front guard open, press the cut buttons. Nothing should happen. If the knife and/or clamp come down with the front guard open, do not use the machine. Repair or adjustment is needed.

Test #2: Close the front guard and press the cut buttons. While the clamp or knife is coming down, open the front guard. The knife and clamp should immediately return to the up position. If they do not, do not use the machine. Repair or adjustment is needed.

Machines with Electric Eyes:

Test #1: Wave a test object 12mm in diameter between the electric eye beams. The indicator lights should indicate the eyes are blocked. If they do not, do not use the machine. Repair or adjustment is needed.

Test #2: If machine equipped with electric eyes, while making a cut, lean into the electric eye beams. The knife and clamp should immediately return to the up position. If they do not, do not use the machine. Repair or adjustment is needed.



We Have it All...



MyBinding.com

When Image Matters.

Guaranteed Lowest Prices on an
Endless Selection of Binding Systems, Laminators,
Paper Shredders, Supplies and Accessories.

We have you covered with Expert Advice
and Support. Our popular blog keeps you up to
date on the latest tips and techniques to make
your most important binding and laminating
tasks a success.

Call Us Today

1-800-944-4573

Our Trusted Partners

GBC / Ibico
Fellowes
Powis Fastback
Unibind
Akiles
Renz
Tamerica
Rhin-O-Tuff
DFG

Pro-Bind
Martin Yale
MBM
Formax
Intimus
Dahle
HSM
Standard
Xyron

Challenge
Lasko-Wizer
GBC Shredmaster
Avery
Wilson Jones
Cardinal
Samsill
Universal



- BINDING MACHINES
- BINDING SUPPLIES
- LAMINATORS
- I.D. ACCESSORIES
- BOARDS & EASELS
- PAPER SHREDDERS
- XYRON LAMINATORS
- COIL BINDING MACHINES
- UNIBIND BINDING MACHINES
- FASTBACK BINDING EQUIPMENT
- PAPER FOLDING MACHINES
- LAMINATING POUCHES
- ROTARY TRIMMERS
- CLEAR COVERS
- TWIN LOOP WIRE
- REGENCY COVERS
- PLASTIC BINDING COVERS
- VELOBIND BINDING MACHINES
- PAPER HANDLING EQUIPMENT
- THERMAL BINDING MACHINES
- PROCLICK BINDING SYSTEMS
- COMB BINDING MACHINES
- COMB BINDING SUPPLIES
- WIRE BINDING MACHINES
- POUCH LAMINATORS
- LAMINATING ROLLS
- 3-RING BINDERS
- ROLL LAMINATORS
- VELOBIND SPINES
- PAPER CUTTERS
- PAPER JOGGERS
- LETTER OPENERS
- THERMAL COVERS
- UNIBIND SUPPLIES
- PROCLICK SPINES
- ZIPBIND SPINES
- LINEN COVERS
- SPIRAL COIL
- INDEX TABS