

# AKILES WIREMAC M

## Instruction Manual



Provided By

**MyBinding**.com®  
*When Image Matters.*

# WIREMAC OPERATION MANUAL

## INTRODUCTION:

CONGRATULATIONS ON THE PURCHASE OF YOUR NEW WIREMAC, A PROFESSIONAL AND HEAVY-DUTY WIRE PUNCH AND BINDING MACHINE. YOUR WIREMAC WAS DESIGNED WITH A FULL RANGE OF FUNCTION AND PREMIUM QUALITY COMPONENTS TO GUARANTEE YOU AN EFFORTLESS AND PROFESSIONAL BIND, AS WELL AS MANY YEARS OF TROUBLE-FREE SERVICE.

## IMPORTANT:

WE RECOMMEND THAT YOU TAKE A FEW MINUTES TO FAMILIARIZE YOURSELF WITH THE FUNCTIONS OF YOUR NEW WIREMAC. YOU WILL FIND THAT WITH JUST A LITTLE PRACTICE, ANY PERSON CAN ACHIEVE PROFESSIONAL RESULTS.

## WARRANTY:

YOUR WIREMAC HAS A ONE YEAR WARRANTY, FROM ITS PURCHASE DATE. IN THE EVENT OF A MANUFACTURERS DEFECT, YOUR DISTRIBUTOR MAY REPAIR OR REPLACE IT. IMPORANT: THIS WARRANTY DOES NOT COVER DAMAGES DUE TO IMPROPER USE OR MISTREATMENT OF THE UNIT, INCLUDING ANY EXTRAORDINARY EVENT LEADING TO DAMAGE OF THE MACHINE, WHETHER IT IS REVERSIBLE OR NOT.

IF THE WIREMAC IS NOT OPERATING PROPERLY, FIRST FOLLOW THE OPERATIONAL MANUAL INSTRUCTIONS. IF THE PROBLEM PERSISTS, PLEASE CONTACT YOUR DEALER FOR FURTHER INSTRUCTIONS. PLEASE HAVE YOUR MACHINES SERIAL NUMBER AND THE PURCHASE DATE READY. IF THE MACHINE MUST BE RETURNED TO YOUR DISTRIBUTOR, IT IS YOUR RESPONSIBILITY TO PROPERLY PACK AND SHIP IT. AS ANY DAMAGES INCURRED DURING ITS TRANSPORTATION ARE NOT COVERED BY OUR WARRANTY POLICY.

## FEATURES

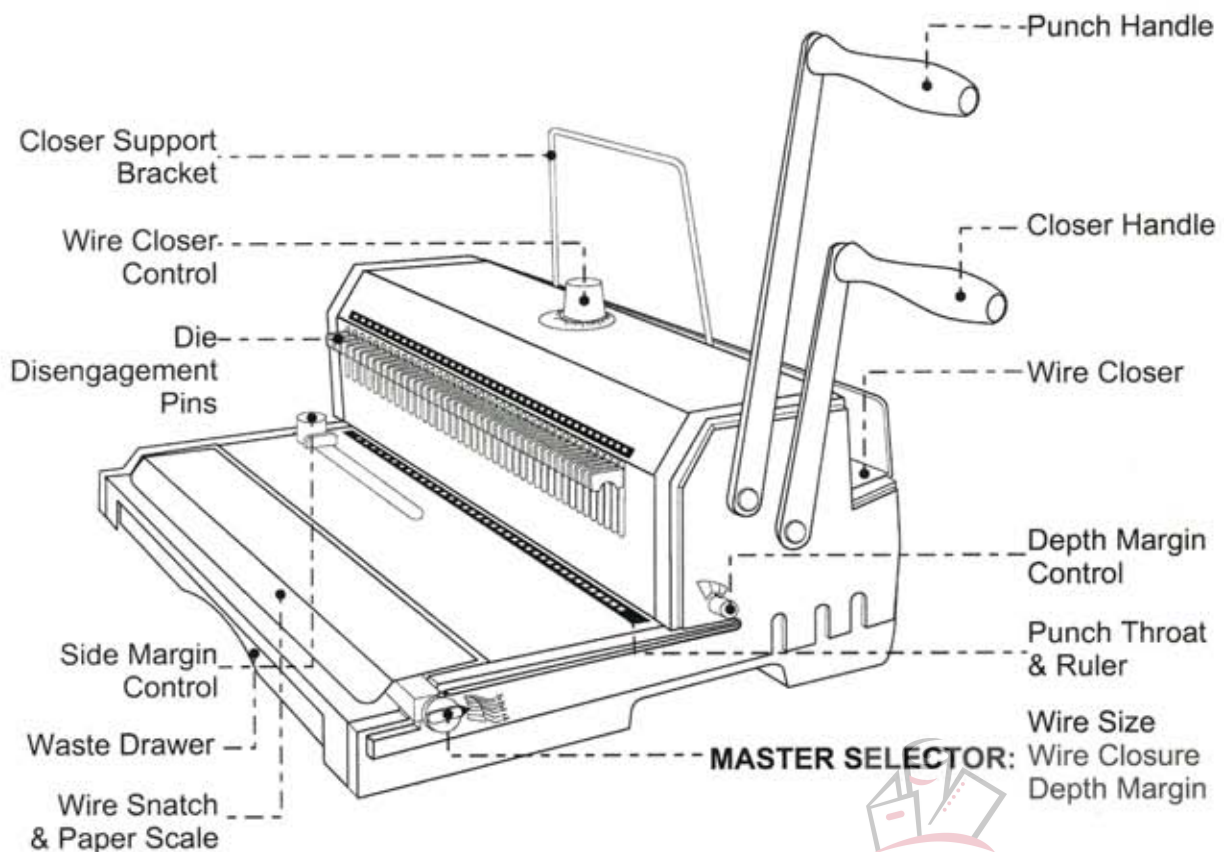

# ASSEMBLY

Place Your New WireMac  
On top Of A Sturdy Working Table.

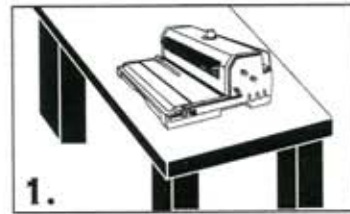

Remove The Screw From Punching Axle  
Connect The Punch Handle ( The Longer One)  
In A Vertical Position Onto The Punching Axle.  
Tighten-Back The Screw Onto The Punching Axle.



To Set-Up The Closer Handle  
Repeat Above Steps With Closer Axle  
& Handle

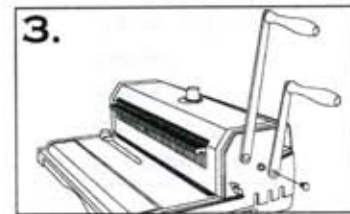

# SET-UP

Insert Your Full Unbound  
Document Into  
Wire Snatch.

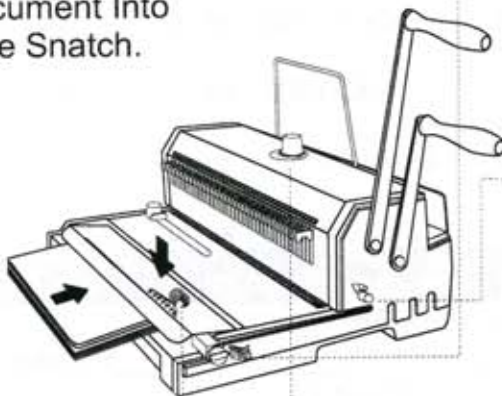

Read The Master Selector  
To Determine The Correct:  
Depth Margin  
Wire Size  
Wire Closure

Set Margin Control To  
The Color Determine  
Depth Margin.  
(Color Indicated On Master  
Selector Should Match Color  
On Margin Contorl)

Set Wire Closer Control  
To The Determined  
Wire Closure Size.

Read The Determined  
Wire Size And Set Aside.

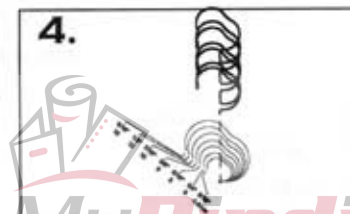
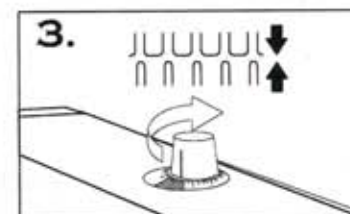
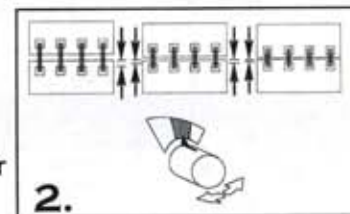
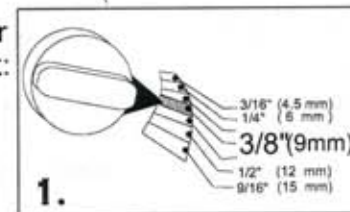

# PUNCHING

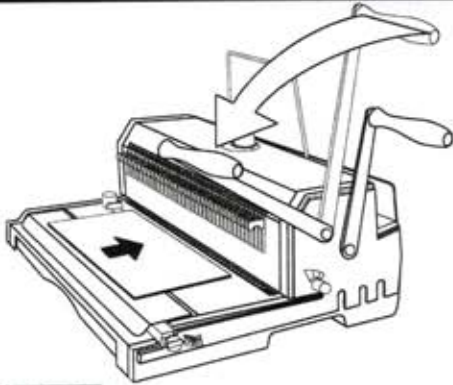

## TIPS

Maximum Single Punching:  
20 Sheets Of 20 Lbs  
or 70-80g/m Paper.

Comfortable Single Punching:  
12-15 Sheets Of 20 Lbs  
or 70-80 g/m Paper.

Punch Inner Sheets And  
Cover Separately As Side Margin  
May Vary.

Re-Align ( Center) Margins  
For Oversize Covers.

Move Side Margin  
Control To Proper  
Sheet & Cover Size.

Note There Are Different  
Side Margins For 11" Sheets  
& Their 11-1/4" Covers.

Pull Out Disengagement  
Pins For Partially Covered  
Holes.

Insert Sheets And  
Pull Handle Forward  
To Punch.

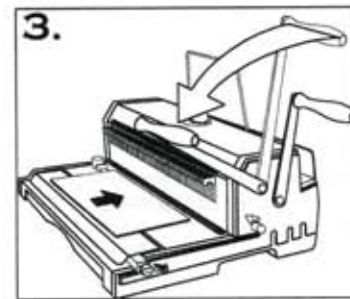
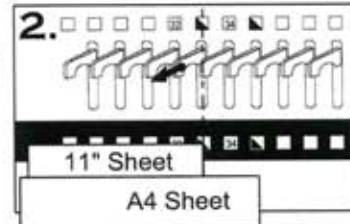
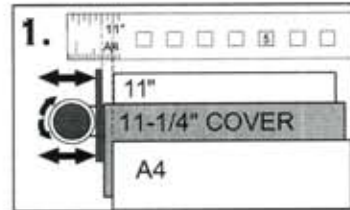

# INSERTING



## TIPS

The Seam Of Closed Wire Should Be Inside The Book.  
Follow Step No.2 Instruction For Best Results.

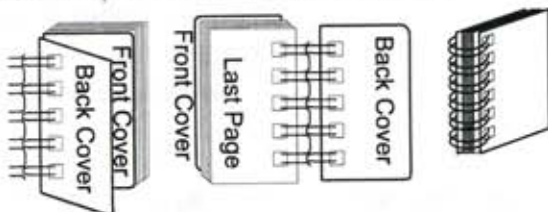

Insert Pre-Selected Wire  
Into Wire Snatch

Insert Document From  
Last Pages To First  
Pages Then Insert Front  
Cover.  
The Back Cover Should  
Be Inserted Last With  
Inside Facing Up.

Take Out Inserted  
Document From  
Wire Snatch To  
Close The Wire.

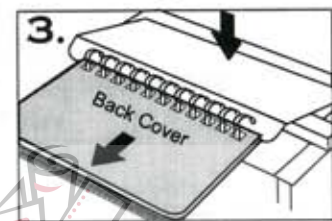
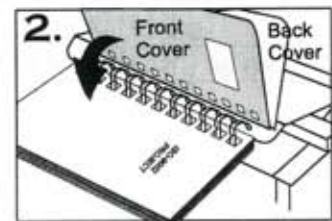
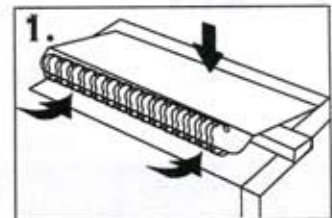

# CLOSING

Raise Up Closer Support Bracket To Hold Document.



Put Inserted Document Into Wire Closer.

The Wire Element Must Stand Horizontally At The Bottom Of Closer.

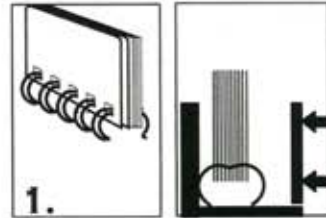

## TIPS

The Seam Of Closed Wire Should Be Just Touching. Slightly Adjust The Closer Control For The Under-Closed Or Over-Closed Seam.

Pull Closer Handle Forward To Close.

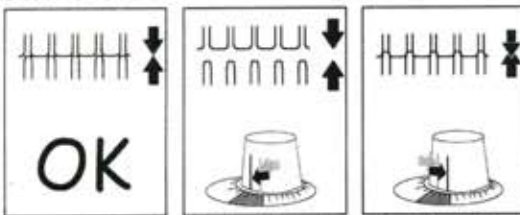
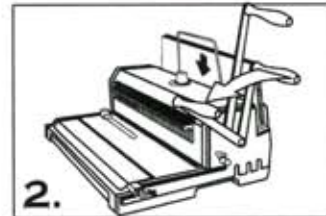

Properly Closed

Under Closed. Adjust Control Clockwise A Few Grids.

Over Closed. Adjust Control Counter-Clockwise A Few Grids.

Take Out Document And Turn Back Cover Over. The Binding Is Ready.



# TECHNICAL INFORMATION

Model	WIREMAC 31 Pitch 3 : 1		WIREMAC 21 Pitch 2 : 1	
	■ ■ ■ ■ ■ ■ ■ ■		■ ■ ■ ■ ■	
Punching Length	14" = 40 Holes		14" = 27 Holes	
	LEGAL = 38 Holes		LEGAL = 26 Holes	
	A4 = 34 Holes		A4 = 23 Holes	
	11" = 32 Holes		11" = 21 Holes	
	8.5" = 24 Holes		8.5" = 16 Holes	
	A5 = 24 Holes		A5 = 16 Holes	
Binding Capacity	Sheets 70-80 g/m <sup>2</sup>	Diameters	Sheets 70-80 g/m <sup>2</sup>	Diameters
		Inch mm		Inch mm
	20	3/16" 4.5	140	5/8" 16 mm
	30	1/4" 6	160	3/4" 19 mm
	50	5/16" 8	190	7/8" 22 mm
	60	3/8" 9	220	1" 25 mm
	80	7/16" 10	280	1-1/4" 32 mm
	100	1/2" 12		
	120	9/16" 15		

# We Have it All...



## **MyBinding.com** *When Image Matters.*

**Guaranteed Lowest Prices** on an  
Endless Selection of Binding Systems, Laminators,  
Paper Shredders, Supplies and Accessories.

**We have you covered** with Expert Advice  
and Support. Our popular blog keeps you up to  
date on the latest tips and techniques to make  
your most important binding and laminating  
tasks a success.

**Call Us Today**

**1-800-944-4573**

### **Our Trusted Partners**

GBC / Ibico

Fellowes

Powis Fastback

Unibind

Akiles

Renz

Tamerica

Rhin-O-Tuff

DFG

Pro-Bind

Martin Yale

MBM

Formax

Intimus

Dahle

HSM

Standard

Xyron

Challenge

Lasko-Wizer

GBC Shredmaster

Avery

Wilson Jones

Cardinal

Samsill

Universal



- BINDING MACHINES
- BINDING SUPPLIES
- LAMINATORS
- I.D. ACCESSORIES
- BOARDS & EASELS
- PAPER SHREDDERS
- XYRON LAMINATORS
- COIL BINDING MACHINES
- UNIBIND BINDING MACHINES
- FASTBACK BINDING EQUIPMENT
- PAPER FOLDING MACHINES
- LAMINATING POUCHES
- ROTARY TRIMMERS
- CLEAR COVERS
- TWIN LOOP WIRE
- REGENCY COVERS
- PLASTIC BINDING COVERS
- VELOBIND BINDING MACHINES
- PAPER HANDLING EQUIPMENT
- THERMAL BINDING MACHINES
- PROCLICK BINDING SYSTEMS
- COMB BINDING MACHINES
- COMB BINDING SUPPLIES
- WIRE BINDING MACHINES
- POUCH LAMINATORS
- LAMINATING ROLLS
- 3-RING BINDERS
- ROLL LAMINATORS
- VELOBIND SPINES
- PAPER CUTTERS
- PAPER JOGGERS
- LETTER OPENERS
- THERMAL COVERS
- UNIBIND SUPPLIES
- PROCLICK SPINES
- ZIPBIND SPINES
- LINEN COVERS
- SPIRAL COIL
- INDEX TABS